

# The Magic of Compound Recruiting

The Secrets of Building a Super Hierarchy

By Hubert Humphrey

Mr. Humphrey is an independent contractor with the A.L. Williams organization. The advice and methods expressed in this book represent the opinion of the author and are not necessarily a reflection of methods endorsed by the A.L. Williams organization. There are thousands of independent contractors within A.L. Williams, each with the right to build his or her business as they see fit within guidelines set by A.L. Williams. This is one man's story.

# C O N T E N T S

## Introduction

The American Dream _____	1
--------------------------	---

## Chapter One

### The Power of Marketing

What is Marketing _____	5
A Hybrid Plan _____	6

## Chapter Two

### A Builder's Mindset

The Magic of Vision _____	9
Two Main Focal Points _____	10
The Dynamics of an Opportunity Meeting _____	11
Build to Maxout Profits _____	12
Depth Provides Security _____	14
Building Keys _____	15
The Myth of Training _____	16
Build It Three Times _____	16
The Final Challenge: Be a Master Builder _____	17

## Chapter Three

### ALW: The McDonald's of the Financial Services World

The Magic of Marketing Mentality _____	19
The Magic of K.L.S.S. _____	20
The Magic of Duplication _____	21

## Chapter Four

### Lots of People Doing a Little Bit and a Few Doing a Lot

That's the American Way _____	23
This Is a Numbers Business _____	24
"Dud Power" _____	25

## Chapter Five

### Speed Width

Recruit in Bunches _____	27
The Magic of Hiring in Waves _____	28
Go Wide Fast _____	28
Sixty Wide in Six Months _____	29

## Chapter Six

### The Magic of Taproofing

A Recruit Isn't a Recruit Until He Has a Recruit _____	33
A Leg Is Not A Leg Until It Is At Least Four Deep In That Leg _____	33

A Team Will Have a Life of Its Own

Once You Find a Leader \_\_\_\_\_

The Super Taproot \_\_\_\_\_

Perpetually Producing \_\_\_\_\_

Overlapping Leadership \_\_\_\_\_

Depth Force \_\_\_\_\_

Two Vitamin Shots to New Recruits \_\_\_\_\_

How Many Can You Spin? \_\_\_\_\_

## Chapter Seven

### The Magic of Compound Recruiting

The Magic of Multiples \_\_\_\_\_

Formula for Failure \_\_\_\_\_

The Magic of Geometric Progression \_\_\_\_\_

The Mystery of the Multiples \_\_\_\_\_

The Popcorn Effect \_\_\_\_\_

Builder's Path to the Top \_\_\_\_\_

## Chapter Eight

### The Power of One

The "No-Excuse" Formula \_\_\_\_\_

## Chapter Nine

### A Recruiter's Mentality

Profile of a New Person \_\_\_\_\_

Sell the Dream and

Crusade Simultaneously \_\_\_\_\_

Become a Student

of Human Nature \_\_\_\_\_

The Ebb and Flow \_\_\_\_\_

Sell the Dream/  
Build the Team \_\_\_\_\_

The Magic of Compound Dreaming \_\_\_\_\_

## Chapter Ten

### A System Whereby Building Never Stc

The Hold-A-Meeting System \_\_\_\_\_

The One-on-One

Opportunity Meeting \_\_\_\_\_

How to Present a Dynamic

Opportunity Meeting \_\_\_\_\_

Preparation \_\_\_\_\_

The Magic of Crowds \_\_\_\_\_

The Presentation \_\_\_\_\_

Suggested Opportunity

Meeting Agenda \_\_\_\_\_

After the Presentation \_\_\_\_\_

Monitor the Numbers \_\_\_\_\_

The Humphrey Management Factory \_\_\_\_\_

How the Factory Works .....	65
Eight Filters .....	67
Review Your Results .....	69
Pushing Up People .....	70
Cranking It Out .....	70
The Buddy System .....	70

**Chapter Eleven**

**Compress Activity/Collapse**

**Time Frames**

The Big Success Secret .....	73
Intensify Your Efforts .....	74
Maximize "Non-Productive" Hours .....	75
Magic of the Blitz .....	76
Stretch for Success .....	76
The Magic of 90-Day Madman Cycles .....	77
Explode to Excellence .....	79

**Chapter Twelve**

**Profile Of The Great ALW**

**Super Hierarchies (The Great Apes)**

North American Sightings .....	83
They Built Great Base Shops .....	84
They Built Strong First Generation RVPs .....	84
They Produced Giant NSD/SNSD-Type Teams .....	85
They Became Master Motivators .....	85
Constant Personal Motivation .....	85
High Octane Motivation .....	86
They Couldn't Live with Being Average and Ordinary .....	86
The Magic of Expansion .....	86
They All Set Goals for Themselves And Their People .....	88
Art Williams On Building .....	88

<b>My Story .....</b>	<b>91</b>
-----------------------	-----------

# The American Dream



**W**e all have a dream of becoming "somebody." Maybe we want to be well known in our community or world famous. We want to do things that will make our families proud of us like becoming wealthy, being paid over \$100,000 a year, or going into business for ourselves and running a big company. We all want to live in our dream home and take vacations in Europe and Hawaii.

Only the free enterprise system allows people who come from humble backgrounds to live their dreams. Everyone in this country has the opportunity to make something of their lives.

---

The founder of Stokely canned foods started out as the widow of a farmer with nine children. After only six years, Anna Stokely and her family were selling 50,000 cases of canned produce annually.

---

Helena Rubenstein, world-famous cosmetician, started out as the daughter of a middle-class Polish-Jewish merchant. Her first entrance into the world of women's

image making was as the owner of her own beauty salon in Melbourne, Australia.

In a free enterprise system, it doesn't matter where you come from, you can be the person of your dreams. I know because it ~~happened to me~~ and I still see it happening every day.

If that's true, why do so many people fail? Statistics show that Americans are among the wealthiest people in the world. Yet 85% of our population is broke by age 65. Less than 1% of our population makes more than \$50,000 a year.

I believe that the number one reason for this is FEAR. People are scared to try. They are afraid of failing and what people will say when they fail so they never take the risk of going into business for themselves. And for most of America, the ONLY way to achieve wealth or fame is to go into business for yourself. Only a handful of people are able to accomplish their dreams by working for someone else.

As a result, most Americans give up the chance to find their dreams. It's easier for them to make up excuses. Here are some of the "reasons" people have given me when

# INTRODUCTION

they explain why they never tried to start their own business:

---

"I don't have the money."

---

"I don't have a college degree."

---

"I don't have any knowledge of a special area."

---

"I don't have any experience."

---

"I don't know what kind of business to go into."

---

"I can't give up my guaranteed income."

---

"I have 15 years invested in my current position."

---

"I'm scared."

---

"I don't like sales."

---

"I can't talk to people."

---

In this book, I'm going to show you the power of a marketing concept that allows ANYONE to go into business for himself and become financially independent. I think it's one of the most exciting business opportunities anywhere.

Don't worry, it's not just about "sales." It's about sales management. There's a BIG difference. Sales and "salesmen" can turn people off. Most people have a fear of talking to others. They're afraid of being rejected. As a ~~railroad conductor~~, I felt the same way. To me, sales was an even bigger nightmare than the job I already had.

There are other reasons not to like sales. In sales, you're unemployed every day you wake up. When you have a job selling something, if you don't go out, prospect and make sales, you don't "eat." It's a lonely profession, and there is NO security because it's just YOU. YOU are your entire business. For this reason, most people don't see themselves going into sales.

But even if you liked sales and were comfortable with the risk, there are other drawbacks, the main one being that your income is limited. You may be able to sell anything to anyone, but one person on his own can only do so much and that's what limits you.

This concept of marketing eliminates the negatives of sales. It enables you to go into business for yourself without a big capital investment. You also have SECURITY. By hiring and training other people, and overriding their production, you can establish a business that has the potential to generate income at all times, even in the event that you are unable to work.

There is also the chance for UNLIMITED income. When you are in sales management, you benefit from the efforts of many, many people, not from your personal production alone.

If this idea appeals to you, I think you will be even more excited after you read

this book. In the following pages, I give you some advice on how you can turn your business life around FOREVER. I take you a step further in "marketing" and challenge you to stretch your VISION. I want you to see the possibilities of building a tremendous business that can secure your family's financial future for generations to come. It can happen. It's happened to hundreds of people I know who earn over \$100,000 each year.

# The Power of Marketing



## What Is "Marketing?"

What do I mean by the word "marketing?" Look around you. Nearly every business you see has something to do with marketing regardless of what that business is. Marketing is simply distributing a product or service to a consumer. There are millions of businesses that we don't think of as "marketing" businesses, but in actuality, marketing is the most important part of the business. Without marketing, there would be no profits.

Take IBM for example. If I asked you what IBM did, you'd say it manufactures business computers. That's only partially correct. It not only manufactures equipment, it **DISTRIBUTES** that equipment. When IBM was the only game in town, it could count on the product to "sell itself." Today, it's a whole other story. There's competition to think about. It has to hire a sales force of people to market its products.

What about Coca-Cola? Marketing

is probably the most important aspect of Coke's success. The availability of the Coke product determines whether Coke will earn \$1 million or \$500 million in revenues. The more stores, restaurants and drink machines that offer the Coke product, the greater the chance that someone will buy a Coke when he's thirsty.

If you had a product to market, which way would be the most profitable method of marketing? Have one person or place to distribute the product or have multiple distribution points? The second choice, obviously, is better. Now what if you could provide incentives that would encourage your distributors to find ways to get more and more consumers to buy the product? You might offer your sales person an override commission on the income generated by his sales group.

Many businesses are set up this way. They have compensation programs that are structured to reward their producers with commissions and overrides or salary increases and bonuses. Some security brokerage firms pay override commissions or bonuses to regional or zone sales managers. The bigger

the production in his territory, the bigger the override the sales manager makes. There is also management at other levels that profits when a territory produces well.

I knew of a car salesman who was about the best in his state. He hired a number of people in various parts of the state to prospect business for him in their area. In return, he gave them part of his commission every time they brought him a sale. Other people at the dealership got a cut of the money - the sales manager earned extra money and so did the general manager. Rewarding upper levels of management for work produced by lower levels is not a new concept. The override is the compensation for sales management.



### Hybrid Plan

The A.L. Williams marketing plan is very similar to the marketing structures of hundreds of businesses. It's especially similar to the General Agency concept in insurance where commissions are earned at several levels.

However, there are some ways in which A.L. Williams is different. The two primary differences are:

- 1 A.L.W. encourages people to go into management as soon as possible
- 2 A.L.W. does HIGH volume

High volume sale of term life insurance is the most effective way to make this expensive product profitable for a company to market. By marketing on a mass scale to the public, A.L.W. is able to realize a volume discount.

A.L. Williams encourages people to go into management as soon as possible because that's where the potential for income and long term security is the greatest. Not only are you capable of earning income by sales YOU make, but you earn income on sales made by people you manage. This is your reimbursement for management, training and motivation. A.L. Williams believes everyone should have the same opportunity for advancement into management. This concept of sales management has produced many people earning \$100,000 or more a year. But there are many distinctions that make A.L. Williams one of the most exciting marketing concepts anywhere. For one, A.L. Williams offers products that can change a person's financial future. At the same time, not just anyone can work in this business. You have to be someone who is willing to get a license and work within the regulations of the financial services industry.

This business takes WORK. You can't just come on board and hope that you hire a bunch of people and somehow the products get distributed. Money is made ONLY when products are sold.

It's practically risk free from a monetary standpoint. There's no big capital investment to make and no inventory to buy. You only have to be able to afford your state licensing fees and a small administrative fee to process your hiring papers. The only real



thing you give up is the time it takes to see if you can be successful at it.

You should never be "alone." You are not just left to figure things out on your own. Everyone is trained.

But the best part of this marketing concept is the opportunity. You can be a victim of "the corporate nightmare" – the feeling that you'll never see the top of that "Ivory Tower." Or you can be a person from a humble background in "Middle America" who might normally never have a chance at an executive level position in a big corporation.

And yet, you can be your own boss and build your own company within a company. You also have the opportunity for unlimited income because you can hire as many people as you are capable of managing and training and you can make as many sales as you like. We will train any good honest person who is willing to make the commitment it takes to be successful.

Best of all, you can do this business part-time. You can keep your salaried job and not feel the pressures that come with living on a commission income.

There are two advantages to the concept of part-time people:

**I** you are able to attract a much higher caliber of person into the business, a person who perhaps is a professional but doesn't want to give up his or her current position

**2** you have maximum efficiency since you are cutting costs such as salaries, office space for employees, etc.

Since you are able to build your own marketing structure within this business, you are greatly benefitted by hiring part-time people.

I hope you are already at the stage of your career that you can see and appreciate the many aspects of this Opportunity. In the following chapters, I will show you the steps to building a "Super Heirarchy," an organization that will continue to produce and grow. At the very least, I hope you catch the excitement of building your own marketing business. It's a concept that has worked for me and I know can work for you, too.

---

#### BUILDING PRINCIPLE

---

Most people crave responsibility and the freedom to work independently. They should be allowed to "own" their work, and be judged on the basis of individual performance. Look for the opportunity in your life that allows you this freedom.

---

## A Builder's Mindset

### The Magic of Vision

One of the first benefits I want you to derive from this book is increased VISION.

VISION is characteristic of GREAT LEADERS in any business. When I read Ray Kroc's "Grinding It Out," I was impressed with his VISION. Kroc was 52 years old with diabetes and arthritis when he first saw the McDonald brothers' hamburger restaurant in San Bernadino, California. As he watched the restaurant employees make hamburgers and french fries for long lines of lunch customers, he IMMEDIATELY saw the potential of duplicating this successful business in towns all across the country. He didn't just think, "I think I'll open one of these 30 miles from here." He immediately began formulating a plan to open NUMBERS of them in many different places.

Willard Marriott also had VISION. When Marriott was going to school in Washington, D.C., he sold hot dogs on the street. At that time, he envisioned restaurants all over the country. His restaurant interests eventually led to a massive hotel chain.

There is a quote by Victor Hugo, "Make no small plans, for they have no power to stir the souls of men." See off into the future of your marketing business. If you think about a little business, that's what you'll build. But if you fully understand the power of building in your mind, if you see an image of yourself building a giant marketing organization, it will come to pass.

As you begin to "see into the future," I want you to imagine two things:

- 1 a large network of outlets
- 2 a large base of multi-product-using clients

Every true marketing person envisions these two things as his ULTIMATE GOAL. Each outlet represents the potential for the sale of products. The more outlets you have the more products you can sell. Once you establish a client base, adding new products that the consumer needs becomes a way to maximize profits.

# T

## wo Main Focal Points

Okay. Let's say you have VISION. Now, what do you do? The answer couldn't be more simple. In fact, out of all the points I make in this book, the ones I'm going to give you here are the most important. If I got AMNESIA and could only remember TWO things about how I built my own marketing organization, here's what I'd want to remember:

- 1 get more and more personal direct legs
- 2 get more and more people ("old" and "new") to Opportunity Meetings

I live by these principles. But what do they mean? Let's see. Point No. 1, "Get more and more personal direct legs," may be self-explanatory. A "leg" is a person or group of people downline from you. Your goal is to always increase the number of people you personally recruit and train and therefore directly override. A direct leg is one of your personal hires who has hired and trained people himself and you override his organization.

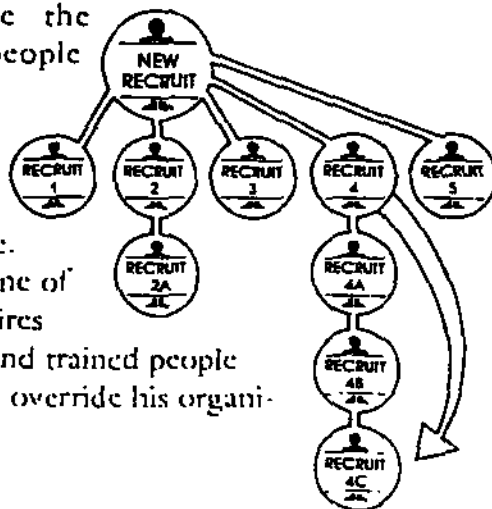

### **WARNING: Dangers of Indiscriminate Recruiting**

\* There is nothing that will wreck your business quicker than doing nothing but hiring "anything that moves." I believe you have little chance of succeeding if you do.

You **CANNOT** just recruit-recruit-recruit without regard to the type person you are hiring and without regard to **TRAINING**. You have to give people you hire the tools for success. Remember no money is made until the product is sold and you can't sell the product until you are **TRAINED**.

**NO ONE** has ever built a good, reputable marketing organization by simply hiring people faster than they can train them. In fact, most of the people who have tried it this way have found themselves out of business in a very short period of time. Generally, they find that they've ruined their name in their community and lost any hope of rebuilding the **RIGHT WAY**.

Every person who has ever built a successful marketing organization has trained or found someone to train every single new person.

Since most of your people are going to be part-time and only working a small number of hours each week, hiring large numbers is not going to affect your ability to get each person trained.

I'll discuss the correct market to recruit from in a later chapter, but for now, you have to understand that your primary concern is looking for people who WANT your opportunity as oppose

to people who NEED it. If someone NEEDS it too badly, chances are they are either in financial straits or they can't hack working hard for a living. While some people in this business have gotten themselves out of financial trouble, the majority never work out. They are in the situation of looking for a way to make cash EASY and FAST. Building your business takes HARD WORK. The rewards are well worth it, but they don't come without a price.

This is not to say that you shouldn't look at everyone you meet as a potential person in your organization - you should. Until someone has tried this opportunity, you have no way of knowing whether or not they will work out. I've recruited people I just knew were going to be Super Stars, and they turned out to be huge disappointments. Likewise, I've recruited people I never thought had a chance who have gone on to build a successful business. This happens because the key to winning at anything is now much DESIRE you have, or your WILL TO WIN. And there's almost no way of measuring that before you hire someone.

## **T**he Dynamics of an Opportunity Meeting

Point No. 2 is: "Get more and more people, both "old" and "new," to Opportunity Meetings. I believe that conducting Opportunity Meetings is an important part of building your business. But unless you understand their purpose you'll never use them effectively. For example, most people concen-

trate on getting "new" people to Opportunity Meetings, and then showing the "new people" how they can set up their own marketing business. This will not build a "Super Hierarchy." Below are the correct Opportunity Meeting objectives in order of priority:

- 1 Re-sell the Dream to the "old" or "existing" team
- 2 Teach your team how to sell the Dream
- 3 Sell the Dream to the new people

As you can see, what many people think is the PRIMARY objective, is actually the THIRD objective. I see people make this mistake all the time. Someone focuses on getting high numbers of new faces at his Opportunity Meeting every week and he thinks he's really building something big. Remember the "warning?" This may work for a while, and certainly people have tried it, but it will never build a Super Hierarchy.

Getting "old" people to come to the meeting is EQUALLY as important as having "new" people there. Why? Because they are your "natural resources." They know about the opportunity. They've been trained, and they know what they're doing. They already know how to sell the products and our business opportunity to someone else; they just need more motivating!

I never "give up" on anyone. I still try to send my mailouts to anyone who has ever gotten hiring papers. I have my assistants call every member of my existing team

EVERY week to see if they are coming to the meeting. (See Chapter 10 "A System Whereby Building Never Stops" for details on how to run a good Opportunity Meeting). This philosophy truly works. Just recently I had a guy who had been "missing in action" for several months. He received one of my tapes in a mailing and now he's reactivated in the business, he's got prospects, he's making appointments. Rejuvenating him was a lot easier (and a lot better for him!) than going out and trying to find someone new.

You'll find that if you call your "veterans," and they come to the meeting and for some reason get excited and motivated again, you get sales results. They've been regenerated. Don't ever discount the potential of these people. They are your natural resources.

Remember: It's the compounding of lots of people doing a little bit that will earn you a big income. If you limit yourself to focusing only on "new" people, you'll never get the numbers working for you. And since you're running a meeting anyway, why not get double your effort?

The number of people at your Opportunity Meeting is just as important as "who" those people "are." Look at this equation:

I have found that if I average 100 people ("old" and "new") every week for a month at my Opportunity Meetings, I will produce about 100 sales that month. Don't ask me why this works — I don't know! I just know that it does and that, not only does it work for me, but it works for other people!

Average No. of People Per Wk at Opp Mtg = Average No. of Base Shop Sales Per Month

(By the way, approximately 60-70% of those sales will come from business produced by your "old" people!)

## B uild to Maxout Profits

We've just talked about building people "direct" to you. What we were actually discussing was a specific building "configuration." That configuration is called building "Wide."

There are three basic ways to build marketing organization:

- 1 "Wide"
- 2 "Deep"
- 3 "Wide" AND "Deep"

You build "Wide" by personally hiring and training people who report directly to you.



When you help one of your personal hires to recruit and train someone, you are building "Deep."

It is critical that you understand the importance of these two terms. Building one way, as opposed to the other, will have a tremendous effect on your long-range income. While I have a lot of people downline from me, running "Deep" in terms of generations of people, I also have a tremendous number of people who report directly to me. To this day, I am still hiring people personally.

Obviously, if you were really going to maximize your profits, you would build both Wide and Deep, because there are rewards for doing both. But if you were going to emphasize one over the other, it is far more profitable to concentrate on building Wide.

As you're building, don't worry about building "Deep." If you hire an ambitious person, your organization may go Deep in spite of you! Many people never really turn into millionaires (in fact, most don't), but they do make a nice, healthy income because some of their downline people built big organizations.

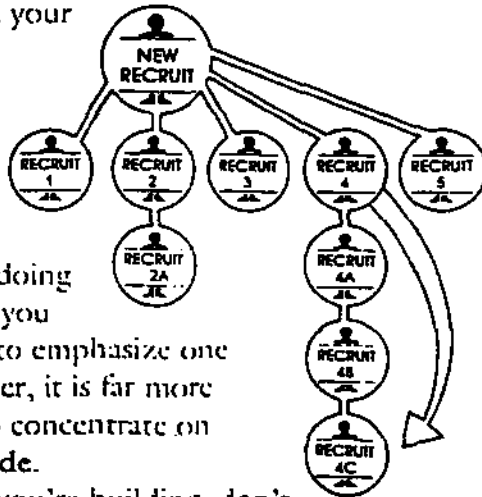

Make a mental picture of the following equations:

Width = Profitability

Depth = Security

Primary: GO WIDE

Secondary: GO DEEP

Remember: You can go Deep after you go Wide but...you can't have depth in a leg you haven't started. You can't have grandchildren until you have children.

Think of this building principle: You can control the planter, but you can't control the plant. Take tomato plants, for example. Most everyone has at one time or another bought those little containers of tomato plants and taken their spade and planted it in their yard. After they watered and fertilized the plant, that's about all they could do. But they **COULD** do one more thing. They could plant another tomato plant! You can't control that plant, but you can control what **YOU** do, and you can get your spade and plant another one. It's the same with recruiting. You can hire someone, but you can't control what he does. You CAN control what YOU do. You can hire another person, and therefore continue to build it Wide.

Let's assume that depth is going to happen in spite of you. No matter what you do, if you hire a few people, they're probably going to hire some people and you'll have at least one leg that's working Deep. There are two pictures that I draw that tell the story of why you should continue to build Wide. The first is a small "mountain" with a flat top.

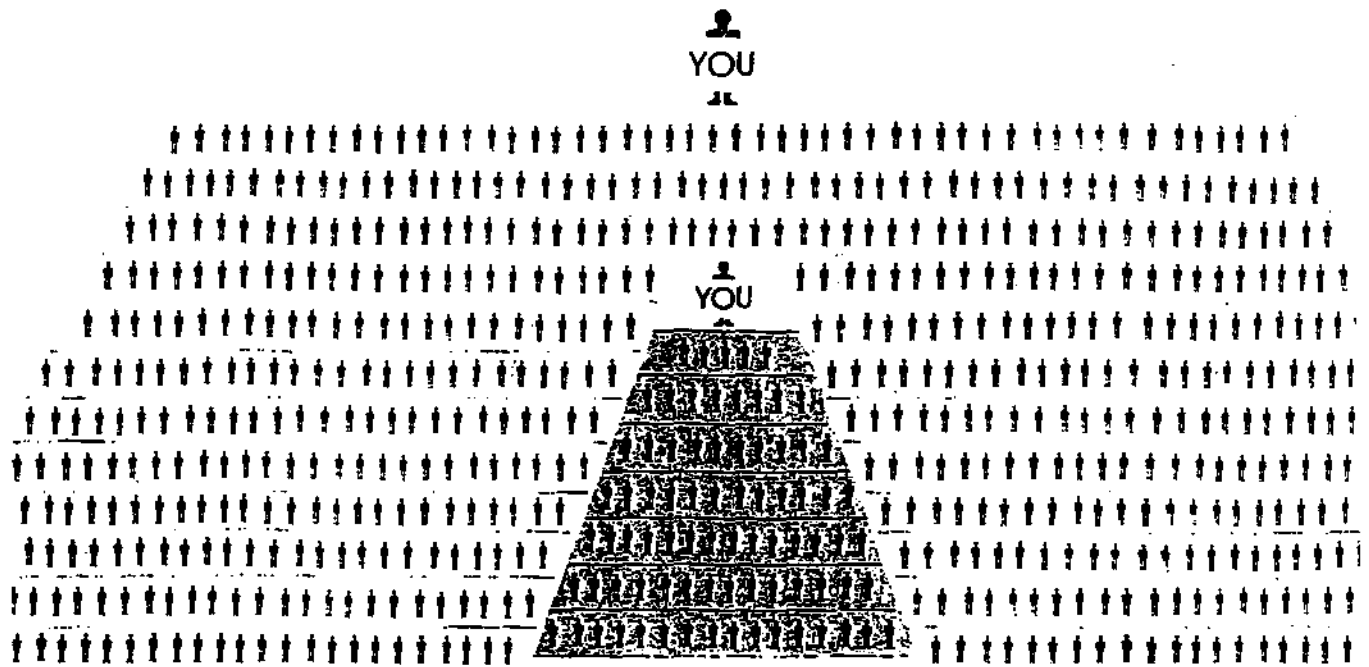

The small mountain above is "5 People Wide," meaning you've hired five people personally. Then I draw down the sides of the mountain from there. You can, and should, draw pictures like this for the people in your organization. "A picture is worth a thousand words." This picture indicates that by working with these five people, they will probably build their own organizations and push your hierarchy Deep.

The second mountain starts with "50 People Wide." Look at the difference in the two mountains. If nature is going to take its course, which way would you like to have your depth fill out? If you're five Wide, there are only one or two who are your core. If you're 50 Wide, there are probably 5, 10, or 15 who are your core.

## Depth Provides Security

**Building Deep** is certainly the **easier** way to build. It's just a **fact** of building that it's easier to help one of your people hire a person in his or her warm market than for you to go out and find a whole new person. This is especially true after you have been in the business for a while and have already worked your warm market (If YOU are the "new person," obviously, the opposite is true). Depth is also easier because if you hire an ambitious person, he may build Deep regardless of what you do.

The other plus to building Deep is that it provides income security. When you are Deep, you should have "Layers of Leaders." These are people who are ambitious like yourself, whom you have trained to build a big organization. Their efforts will provide

compensation to you at all times in the form of override commissions.

Even if you are unable to work, depth means you will still receive good income. There's income from a large group of people. You can't be devastated. Your income is insulated against adverse circumstances such as getting sick, disability, etc.

## B uilding Keys

I remember two things a friend once told me about building a successful marketing business. The first was "Don't resort to 'Panic Management.'" He described the causes of Panic Management as:

- 1 lack of money
- 2 lack of activity
- 3 lack of a definite, sound business philosophy

Most people don't build a big marketing business because they suffer from No. 3.

The second thing he talked about was his philosophy of "building outlets." He said:

- 1 opening outlets is an all-time thing
- 2 have quantity to get quality

For now, I want to explain Principle No. 1 because it relates specifically to a Builder's Mindset. No. 1 is another way of saying, you must have a "Hiring Mentality." You can't build unless you do. Do not make the mistake of focusing on SALES. You must think OPENING OUTLETS. I like to say,

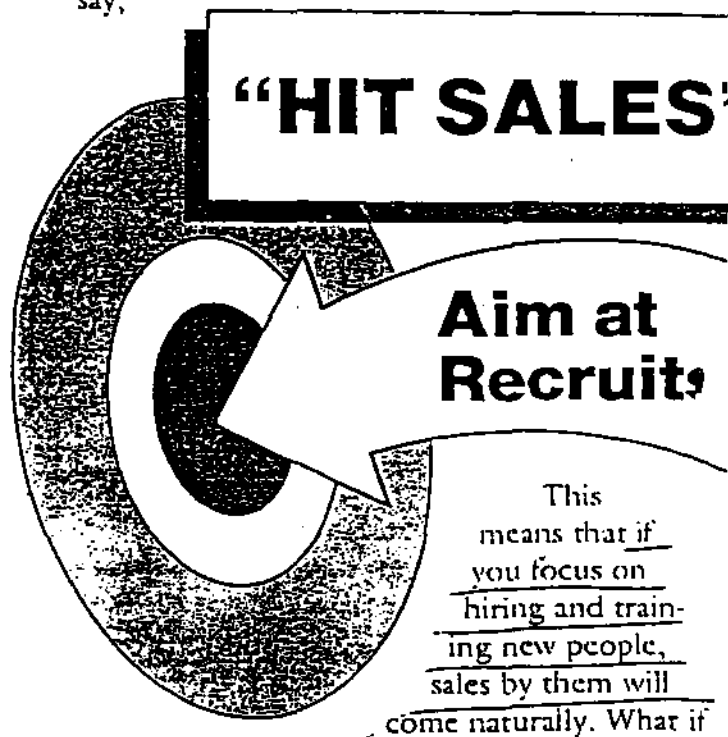

you don't succeed in hiring that person? That's okay, too, because he or she may still become a client who is happy using the product. To get these two possibilities working for you, you have to look at every person as a potential "outlet" FIRST. Don't make one list of people you're going to "sell," and another list of people you're going to "hire." You personally don't have the omnipotent power of determining which a person will be! You shouldn't deny someone a chance to become part of your team. You're hurting them and you're hurting yourself.



## The "Myth" of Training

At first, the phrase "The 'Myth' of Training" sounds like a real negative. It sounds like I'm saying, "training is a joke" or "you don't need training." That is NOT what I'm saying. As I said earlier, training is CRITICAL. Remember: Only sales produce income and training is mandatory for sales. But some people have a mistaken view of how to train. The word has a certain "mystique" about it. Some people even use training as an "excuse" for not doing the activities that will later bring them sales and help them build a team. As a result, the tendency for most people is to:

- 1) hire him
- 2) train him

This is lethal to the person wanting to build a Super Hierarchy. A Builder's Mindset says:

- 1) hire him
- 2) help him build his own team

If I'm field training you, we basically have two options: 1) we can make field training sales OR, 2) THROUGH field training, we can begin to find people who will become a member of your team once you are licensed. In both options, you're going to receive the traditional form of "training." But Option No. 2 also means that you'll have MORE than just field training sales, you'll have the potential for a team once you are licensed.

Would you rather be trained and get a few training sales? Or would you rather have training, and some sales and the potential for a lot of sales through your future team?

## Build It Three Times

Whatever you expect or hope to accomplish, you must build it three times

1 Build it in your mind

2 Build it on paper

3 BUILD IT!

First, build your Super Hierarchy or whatever it is you're planning - in your dreams. I mean this literally. Take my office building as an example. Someone had to dream that building in his or her mind first. Every detail was thought out, and then they made a blueprint. That's the second step, building your dream on paper. When an architect builds his dream on paper, then the contractors and subcontractors with all their workmen can physically put the structure together.

Handle every aspect of your business this way. Think about it, write it down and then do it. Some people just jump out there and start building from scratch, with no plan and no vision. What kind of a building would you have if you did that? If I have a training school or I've got a day with interviews or we're planning a big Opportunity Meeting if I'm trying to earn a promotion or a certain level of income, I go through every step in my mind first. Then I write it down. Then execute it.

"For where there is no vision, the people perish!"  
Proverbs 29:18

# The Final Challenge: Be a Master Builder

The final step in developing a Builder's Mindset is to see YOUR role in the business as that of a "Master" building contractor. So many people who come into business take their mind off their main goal. They

get bogged down by sitting behind their desk doing paperwork. These people become what I call "carpenters." They're experts in their own specialized field, but they have nothing to do with developing the "big picture." They're not the Master Builder. Your goal is to see yourself as the contractor, building a giant "house" or team.

## DEVELOP A "BUILDING MENTALITY"

### "MASTER BUILDER" BUILDING CONTRACTOR

1. Envisions completed project before he starts to build.
2. Has blue prints drawn up in great detail.
3. Determines HOW much RAW material/supplies/workers are needed to complete project.
4. Determines how much it will cost to do the job.
5. Sets a deadline for completion.
6. Develops a business plan to:
  - a. Hire
    - Painters
    - Brickmasons
    - Plumbers
    - Electricians
    - Roofers
    - Laborers
    - Carpenters
    - Subcontractors
  - b. Negotiate constant and sufficient CASH FLOW to finish the job and stay in business (normally with a bank)

### "EMPIRE BUILDER" SUPER HIERARCHY BUILDER

1. Has a clear mental picture of being the "Leader of Thousands"
2. Prepares a plan to reach GOALS, as shown on page 36 of "Think and Grow Rich" book.
3. Determines how many Prospects, Interviews, Recruits, PPU's, Sales, Managers, RVP's it will take.
4. Determines how much energy and time it will take and what things must be eliminated/sacrificed.
5. Sets Daily, Weekly, Monthly, Yearly, and Multi-yearly deadlines for accomplishment.
6. Develops a Business Plan to:
  - a. Recruit/Train/Develop New People
  - b. Makes enough personal sales and training sales and always personal recruits to keep "the spread" balanced. This ensures sufficient cash flow while developing KEY LEADERS.

The chart at the left is something I developed to show the similarities between an "Empire Builder" and a "Building Contractor."

### BUILDING PRINCIPLE

Don't major in minor things. Don't fall into the trap of concentrating on what's EASY - like paperwork! Find a good, administrative-oriented person to handle the details of running an office. YOUR job as the Master Builder is to see the "big picture" and focus on activity that will generate income, such as recruiting and training!

# ALW: The McDonald's of the Financial Services World



## The Magic of Marketing Mentality

Chapter Two discussed the importance of VISION. You were told to see yourself building a Super Hierarchy. In this Chapter, I want to specifically talk about opening outlets. To think with a "Marketing Mentality," think of your business as the ultimate DISTRIBUTION SYSTEM, a system you could use to market ANY product to consumers.

If you need an example, look at any company in sales, any company that mass markets a product. I like to use Coca-Cola and McDonald's, two companies that have been so successful they've become household words. There were two basic factors that determined how large these companies could grow (how much of a market they could capture):

- 1 Continuous opening of outlets
- 2 Volume production per outlet

The most important factor is No. 1, the "continuous opening of outlets." For McDonald's, the outlet is a hamburger stand. For Coca-Cola, an outlet is the store that sells Coke or the drink machine in a lobby. If you're on a remote country road somewhere and get thirsty, you can go into the general store and there'll be Coke on the shelf. Then you can go 20 miles down the road to a big grocery store where they will have rows and rows of Coke. They sell truckloads and cases each week. Or, you can check into a hotel and up on the fourth floor, find a drink machine that offers Coke. It makes very little difference whether a store or machine sells one Coke or a thousand Cokes a day. The Coca-Cola company is much more concerned with having many outlets.

Only after you have a large number of outlets do you begin to concern yourself with factor No. 2: volume production per outlet. Just how many drinks are being sold in this store? You better have your system in place before you get involved with increasing the number of Cokes sold in each store.

In this business every person is an outlet. YOU are an outlet. An outlet is anyone who can offer the product to the consumer. The difference between this business and other marketing systems is that as an independent contractor, YOU have the ability to set up your own distribution system within the big network.

To build a distribution system, you should adopt the mentality of continually opening new outlets – more and more and more outlets. Once this system is in place, even if the majority of your outlets are producing just a little, with only a few doing a lot, you are on your way to building a Super Hierarchy.

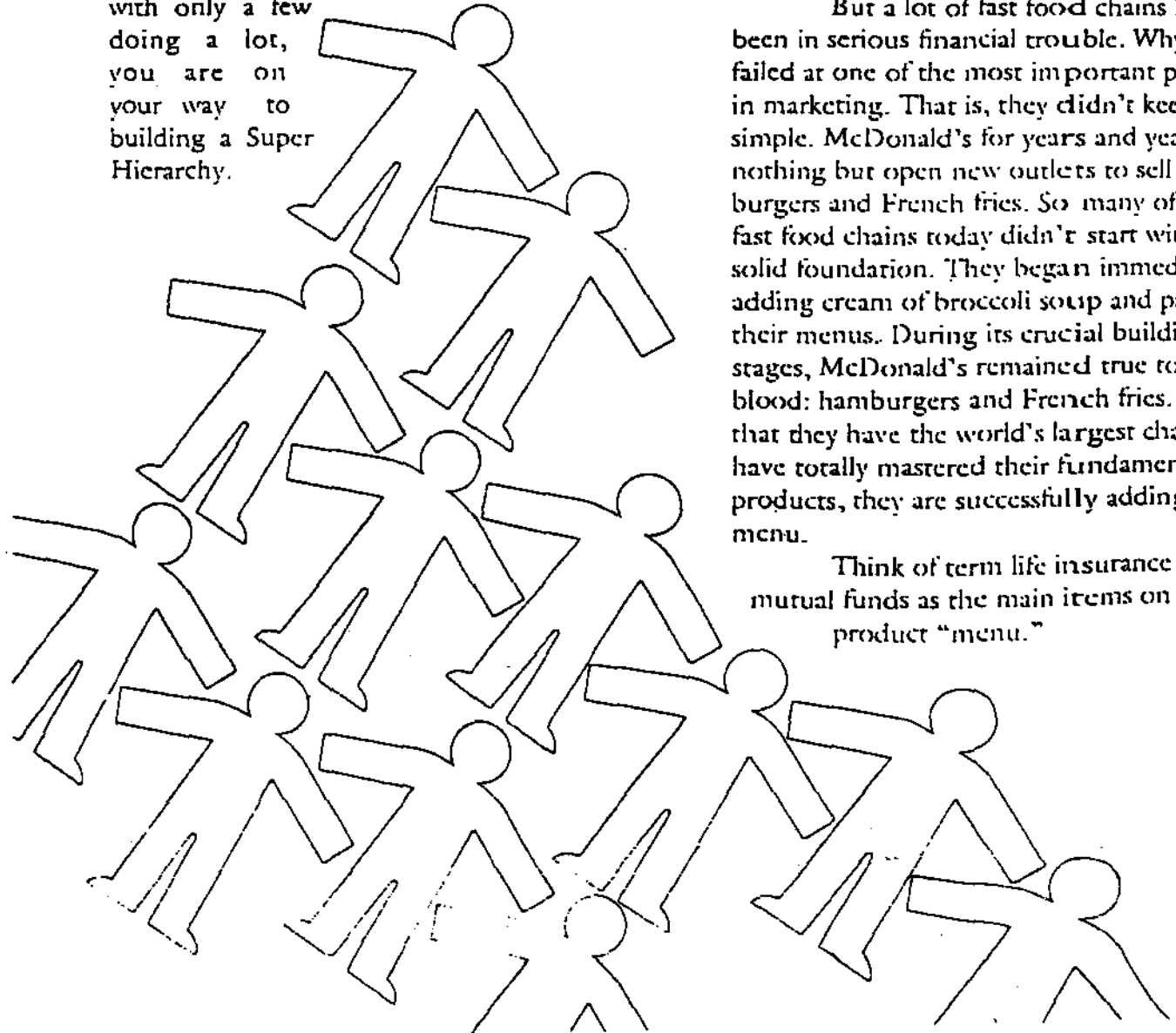

**T**he Magic of K.I.S.S.  
 (Term Insurance and Mutual Funds Are Our “Hamburgers and French Fries”)

You’ve heard of K.I.S.S. – “Keep It Simple, Stupid.” These words are a secret to building. One of the most fascinating industries of this century is the fast food restaurant business. Over the years, new chains of hamburger stands have opened – all based on the example set by the granddaddy of hamburger stands, McDonald’s. The concept of selling hamburgers and French fries looks easy enough – judging by McDonald’s success.

But a lot of fast food chains have been in serious financial trouble. Why? They failed at one of the most important principles in marketing. That is, they didn’t keep it simple. McDonald’s for years and years did nothing but open new outlets to sell hamburgers and French fries. So many of the new fast food chains today didn’t start with that solid foundation. They began immediately adding cream of broccoli soup and pasta to their menus. During its crucial building stages, McDonald’s remained true to its life blood: hamburgers and French fries. Now that they have the world’s largest chain, and have totally mastered their fundamental products, they are successfully adding to the menu.

Think of term life insurance and mutual funds as the main items on your product “menu.”

## The Magic of Duplication

There is one more marketing lesson to be learned from the marketing genius of such companies as McDonald's. It is one thing to successfully open an outlet, but to make each outlet a success takes something special. I call that something, "the Magic of Duplication." You must have a blueprint that is easy for people to follow. It doesn't necessarily have to be copied to a tee in each outlet, but it must be close.

When Ray Kroc saw the first McDonald's selling a lot of hamburgers, he was impressed. He realized immediately that his ability to duplicate the McDonald brothers' system of making the burgers and fries would be critical to his success. That's the way to build your business. Find a solid person, train him, teach him exactly the things he needs to know to win. Keep it simple. Then teach him to teach it to someone else. Make the blueprint for your business, your motivation and recognition program or recruiting program, easily transferable.

In my organization, I have kept the same system for years. This is the system (with some modifications) that most of my successful RVPs adopted. Most of the recruits entering the Humphrey Worldwide Network, follow the same blueprint.

There are "blueprints" in every facet of this business. The Asset Management presentation, for example, and the three-step sales process.

Of course, the best way to get a high level of performance is to be sure that the

master copy is worth duplicating. One person in my organization has done a great job of duplicating. He was able to hire and train hundreds of people in the San Jose area by taking my basic recruiting principles and Management Factory System and adding his own personal touches.

---

### BUILDING PRINCIPLE

---

Whatever you do, don't quit. No matter how talented you think you are, you're going to be challenged. Expect the first 18 months of your effort to be difficult. Give yourself enough time to win in business. The first 3-5 years is nothing but survival.

---

# Lots Of People Doing A Little Bit and A Few Doing A Lot

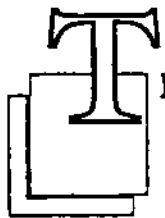

## That's the American Way

One of the most important principles in building is realizing that you don't have to find a lot of Super Stars to build a superior marketing organization. Lots of people doing a little bit is better than a few people doing a lot. Of course, it's BEST to have both, but if you can't, you would generate more income by choosing the first option.

Our whole society is built around the principle that only a very few people "do a lot." Look at the United States. In our nation, there are probably 230 million people. We have only one president. He's the only person who's considered our ultimate "leader." We also have only a few congressmen and senators. In the world of business, approximately 90% of all working people work for someone else. The other 10% are among the few people who put it all on the line and run their own business. What about wealth? There are probably a million millionaires and only a handful of billionaires.

The fact is, not everyone you meet

or everyone you hire is going to be a Super Star in business. In fact, for whatever reason – mostly because they aren't willing to give the effort it takes – the great majority are going to remain part-time, every now and then generating some business. You should NEVER feel bad about this concept. All we can do for the people we recruit is:

---

1 give everyone an opportunity

---

2 give everyone examples of success

If someone wants to condemn the fact that we advocate part-timers, he should take a close look at the structure of our government. Most of the legislatures in the various states are filled with part-time legislators. What about George Washington's army? None of these men were professional soldiers, most of them didn't have uniforms, they were part-timers who were known as "rag tag" by the Loyalists. For many, many people, part-time opportunities of all kinds are a way to earn extra income, and that's the way they should stay.

# This Is a Numbers Business

The "Law of Averages" says that not everyone you hire will be a Super Star and not everyone you hire will even remain with you. In any business, people become disinterested and quit.

The only way to overcome the negatives of the Law of Averages is to harness the power of the "Law of High Numbers."

Think of it as owning a greenhouse nursery. Every time it's planting season, you plant hundreds and hundreds of seeds and seedlings, knowing that not all of them will make it. That's the way you should see building.

I use the analogy of the baseball player who went to bat three times in the first game of the season and got one hit. His average was .333. That is the average of a future Hall of Famer. Did he get to negotiate a million dollar contract? No. But if he goes to bat 600 times and still has a .333 average, meaning he's gotten 200 hits, then he can call the shots when it's time to negotiate a contract. You must have high numbers if you expect to become a Super Builder.

Let's assume that the Law of Averages says that you will be able to hire one or two out of every four people you approach. Look at the following projection chart, and you will see what you have to do to build a Super Hierarchy.

## The Law of Averages at Work

Hire 25-50% of all your prospects

400 interviews = 100 new people

100 people = 50 licensed agents

50 agents = 1 RVP & 50 associates

25 RVPs = 1 STRONG Builder

Total financial independence can be achieved by building 7-10 STRONG Builders. How many recruiting interviews will it take? About 10,000 total interviews.

But don't get discouraged by this! You are not doing it all yourself! You are getting the numbers working for you. You are building leaders who are helping you work the numbers. In fact, if you are discouraged, I suggest you read Chapter 8. That Chapter shows you how you can build a marketing organization that generates a million dollars a year just by working with five people.

*\* must Beek this down  
be speed - how many ways can  
we get this done*

## “Dud Power”

Don't get me wrong. By the word “dud,” I do NOT mean a person who is “undesirable” to have in your organization, or one who is a “failure” at building a big business – although that's the meaning most people have in mind when they call someone a “Dud!” I am talking about people who, by choice, only give it enough effort to do a small amount of business.

Never “fault” these people. And never take them for granted. Remember that the Law of Averages says not everyone you hire will be a Super Star. Don't let this worry you. You can have a bunch of “duds” on your team, and you may be on your way to building a Super Hierarchy! In fact, your only problem could be that you don't have ENOUGH “Duds!”

I heard a story about a man with another marketing company who put out a memo to everyone in his region. The memo said, “I want to be known as the guy with the most ‘losers’...because the guy with the most ‘losers’ will also be the guy with the most winners.” Of course, the “powers that be” didn't care too much for this memo. They claimed they didn't have any “losers” in their company. It would be wonderful if this were really true. But reality says that for whatever reason – mostly because they don't want to give it the effort – some people are not going to be a “whiz” in the business. But the MORE total people you have, “Duds” or not, the more likely you will find a “Fireball” leader.

Don't let “Duds” be a negative.  
Remember: The leader with the most  
“Duds” WINS.

---

### BUILDING PRINCIPLE

---

You can't change people's basic qualities, accept them the way they are. If you want people to succeed or improve themselves, start by praising them when they begin to do things right. Always look for reasons to praise people.

- \* Praise and recognition are the most powerful forms of motivation. Always praise. Always look for something good to say.
-



## Speed Width

### Recruit in Bunches

To say you're going to "go Wide," isn't enough. "How Wide?" is also a consideration. When trying to build, how can you tell who will make it in this business? You can't. I certainly can't, and I've been building for 11 years. The people who are serious about winning ("Studs") and those who just give it lip service ("Duds") all look alike when you're first talking to them. That's why you should look for a BUNCH of people. There is just no way of prejudging a person when you are trying to hire him. He may look good and sound excited about the business opportunity, but never amount to anything.

When I used to coach midget league basketball, we would have 20-25 kids show up for our first practice. At the beginning of practice, most of the kids looked alike in terms of ability. But after putting them through drills, watching them run, dribble, pass, and shoot, I could determine who our

best 5-8 players were. Some who looked like they would be great before we started, turned out not to be the "Studs" I thought they were and vice versa.

Since this business depends on a person's desire and WILL to WIN, you just can't tell who your first string is until they've gone through a little practice.

Hiring in bunches will also help you avoid another pitfall – the tendency to "wait" because of two or three "good" people. You say to yourself, "Boy, I hired this guy and he looks good, sounds good, smells good, man, he's just EVERYTHING." Then what happens? You don't hire anyone else because you tell yourself that you need to spend all your time with your new "Stud." You sit there, and a week or two or three goes by, and you should have been looking for more people. What happens when you wait? After a while, when you wake up out of the "coma," you get mad. You get mad at yourself, you start getting frustrated with your people and don't treat them right. But you don't have a right to get mad at others. You can't "make them" do ANYTHING.

Remember: Even if you've found "Superman," you must be looking for more people.

I call it the "next" mentality. Next? Who's next? Think of it like a doctor's office. They bring you in, you take off your clothes, slip on a robe; then they make you cough, and while the doctor's attending you, the nurse runs out into the waiting room, "Next?"

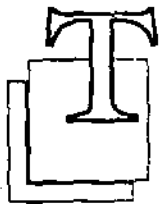

### The Magic of Hiring in Waves

You must develop a rhythm of hiring at least 3 <sup>(12)</sup> personal people every 30-45 days and invest as much time as possible with the ambitious people (the people with the most desire to win). By hiring one good, new "Fireball" and helping him build in his market, and even downline to the markets of his new people, you should build up a wave of 7-10 new prospects at the next big Opportunity Meeting night. Wave recruiting builds momentum.

One Christmas I asked my wife, Norma, to give me a "Wave Machine" - one of those glass objects with colored, moving liquid. You turn it on and it rocks back and forth and the liquid makes "waves" to the sound of an ocean. I keep it in my office to remind people they should build momentum by hiring in "waves."

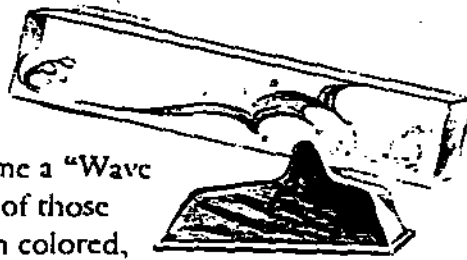

\* must get 10 new people per week

- ① 10 weeks
- ② 20 weeks
- ③ 30 weeks
- ④ 40 weeks
- ⑤ 50

## Go Wide Fast \*

Recruiting in waves is closely related to the speed at which you hire. Let's say, for example, that two people each have a goal of building outlets.

The first person goes out and hires one man or woman every month for a year - 12 people. Sounds like a steady builder, right? The second person goes out and hires 12 people in 30 days.

Who's going to get the most benefit from the effort put out to get 12 people? The guy who hired one a month for 12 months, or the guy who hired 12 in 30 days?

*Key:* The first person was a "steady" builder, but by the time the 12th person was in, 8-10 of the others may have died of boredom. They never got to see each other. Maybe they were never in the room at the same time. They were never at your base shop at the same time! They weren't on any Leaders Bulletins at the same time.

The second person who hired 12 in 30 days saw immediate results. More people were motivated to hang in there. They could rely on each other for morale and motivation. Even though the Law of Averages says you're always going to have a few who aren't really serious, aren't really committed and are eventually going to fade away, these people contribute to synergy. That's why you want to recruit quickly. In every crowd, you're going to have some people who are nothing more than professional meeting attenders. That's okay. That's their right. They're certainly not "bad" for your business. They actually help

your winners to feel more a part of a team. How would you like to be on a basketball team with only five players? When you looked over there on the bench, there would be no one there screaming and cheering for you. People like to feel part of a team.

## Sixty Wide In Six Months

I have personally done this four times in my career. Four times, I have gone in one streak, building 60 people direct to me in a six-month period. This is what allowed me to be where I am today.

At one point, I had completely shut down my base shop. I realized that to maximize profits, I had to rebuild my base (remember those who build it **Wide first WIN**). So after three years of shutting down my base, I went back out into the field and built 60 wide in six months. After that, I had 120 people reporting directly to me in my base shop. That effort took us into the \$70-80,000 premium-a-month range. I knew I could do it because that's exactly what I had done in 1979-81 in Denver. I had more than 10,000 people trained and reporting to me. When I came back to Georgia, I did the same thing with my Georgia base shop. I built over 1,000 people in the first six months.

During the four years my base was monumentally big, it never got below 50 producers, meaning people who consistently did something and reported directly to me. If

you go 60 wide in six months, you should expect to find at least 20 serious people who want to win.

I use the chart on the next page as a target. If there were physically enough room on the page, each of those circles would be radiating out from a central circle (you). Each circle represents a person or a prospective new hire.

The chart visually explains to a new person the "60 Wide in 6 Months" plan. The person uses the sheet two ways. One is his planning stage, in which he takes a pencil and fills in the names of people he thinks are going to be his next five or 10 people. Then, when he actually gets them, he writes their names in ink. I ask the person to turn it in to me every month. If it's blank, I say, "Just hand it in." If it's got one name, fine. If it's the same name next month, fine. The point is to keep it in front of them, give them something to shoot for.

Whether you are shooting for 30 wide in six months, or 10 wide in six months, always project a plan. You can't help but get big FAST if you put out that kind of a personal building effort.

---

### BUILDING PRINCIPLE

---

Treat your people with respect. They aren't numbers on your own success chart. They are real people who deserve to be treated with courtesy and respect. All great leaders add the human factor to all aspects of their business.

---

# GO 60 WIDE

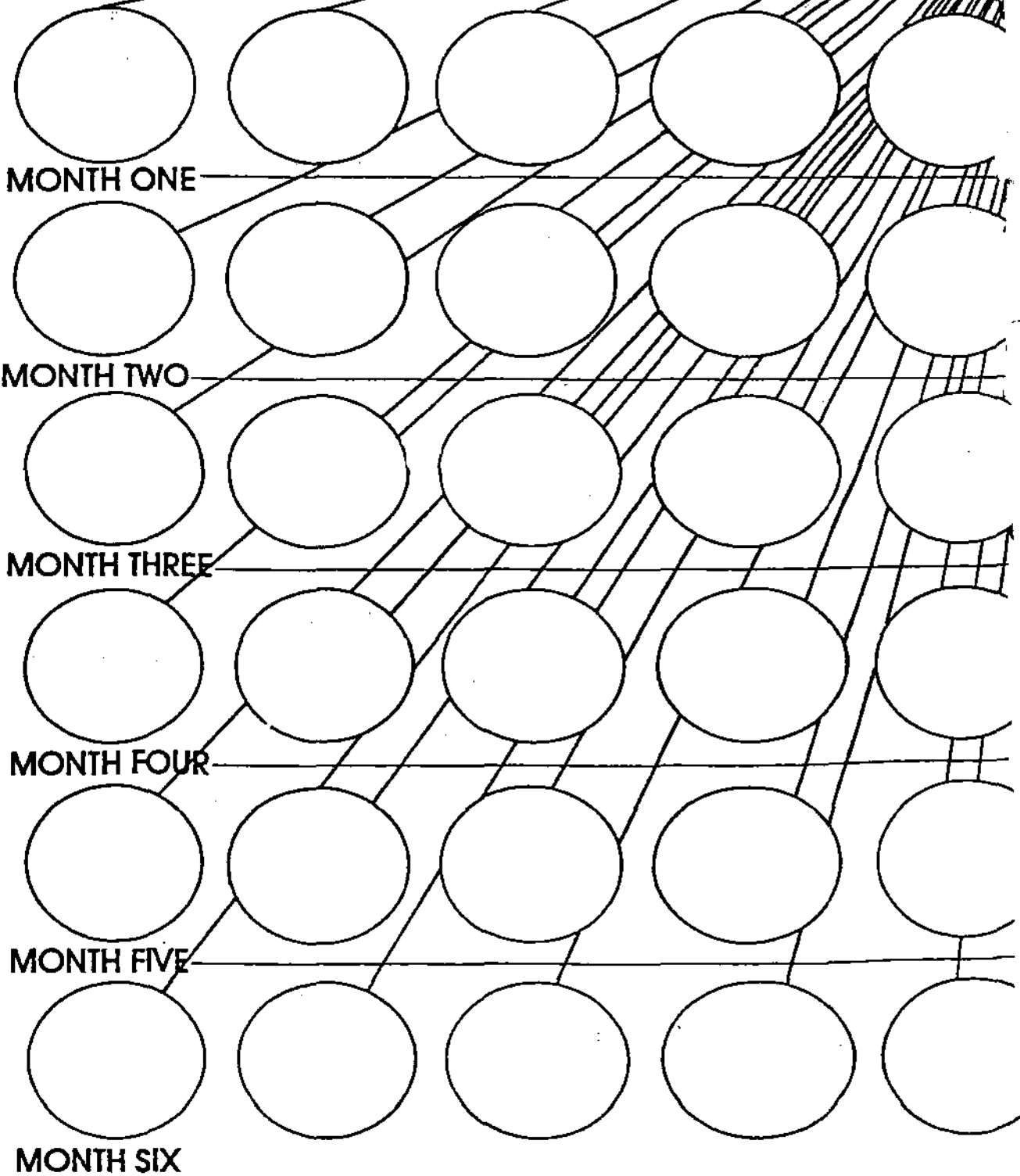

# The Magic Of Taprooting



## Recruit Isn't a Recruit Until He Has a Recruit

A new person really isn't anchored into the business until he or she has:

- 1 become trained and licensed
- 2 become a crusader for term ~~insurance~~ <sup>PPL</sup> and made sales
- 3 recruited a new person

There is a big difference in just "signing up" someone, and anchoring him into the business. Anyone can do No. 1. A lot of people can do Nos. 1 and 2. But the person who is serious about a business opportunity, and the person you can consider part of your building effort, is someone who has done all three.

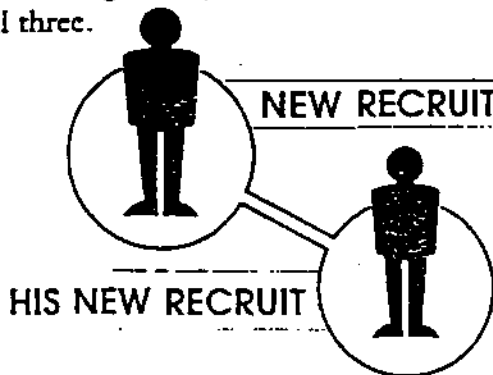

## Leg Is Not A Leg Until It Is At Least Four Deep In That Leg

Now let's assume that you have a "for real" person. He's taken each of the three necessary steps. Do you have it "made?" No.

What if your "good person" drops out? If this happens early, the team people he brought into the business may leave also. They've lost the main bond that they had to the business. If you TRULY want to build a team, each person you hire should hire at least four people.

The Law of Averages says that at least one of those people will remain a serious, committed person.

Building four people Deep also creates excitement for your good person. It motivates him to want to stick with it. All of a sudden, he has a team. He says, "Man, my team is growing!"

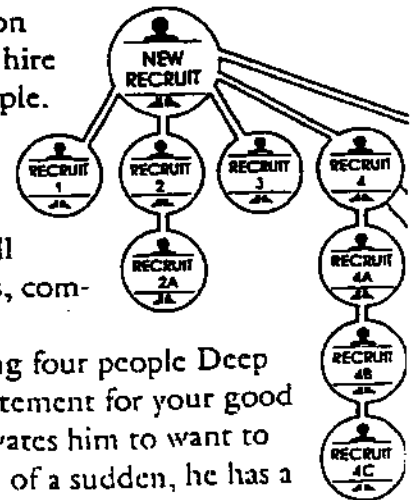



**Team Will Have a Life of Its Own Once You Find a Leader**

Building your business by developing teams that are four deep will create solid business. Recruiting and training "Wide" is building by addition. Recruiting and training "Deep" is building by multiplication. But identifying one leader in each team will enable you to harness the Power of Geometric Progression.

Your leader in that leg will continue to recruit and train and develop teams while you build in other areas. The leader ensures that his team will have "a life of its own." Until you have developed at least one leader in each leg at least once, you're really not going to have any strength.

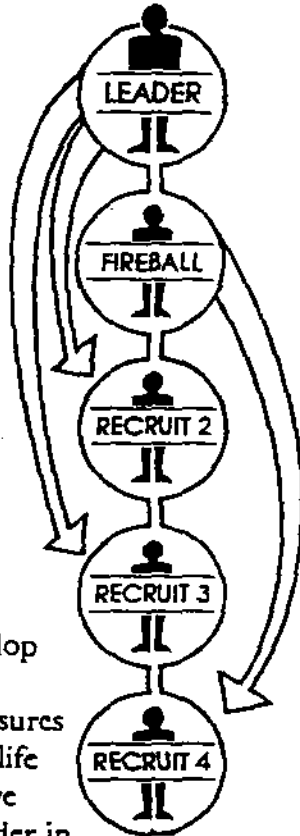

**The Super Tap Root**

The "Super Taproot" is a system for maximizing the concept of replacement. You already know that in order to be promoted, a person must replace himself or herself with one team in his or her organization to be assigned directly to his upline manager. By working temporarily in depth, you can build permanent width as you receive a replacement team from each new leader you promote. You can target yourself for a healthy replacement by helping your direct recruit to build Deep.

Let's assume you interest five or six people in your business. The Law of Averages says one of those recruits will be what I call a "Fireball." This is someone who's urgent and

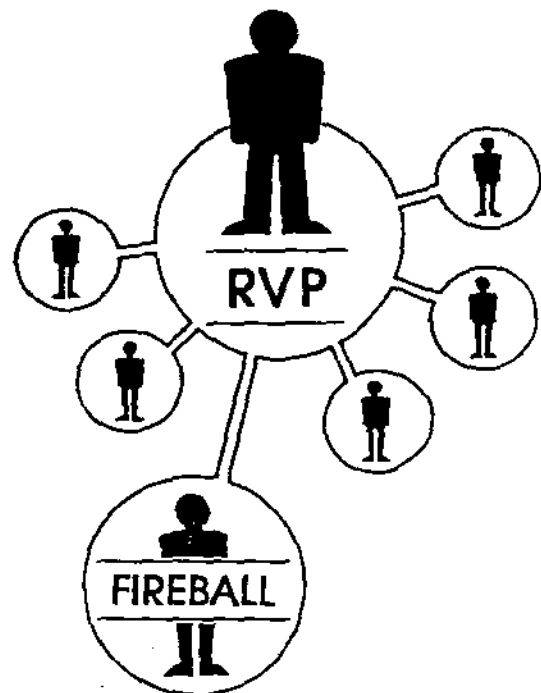

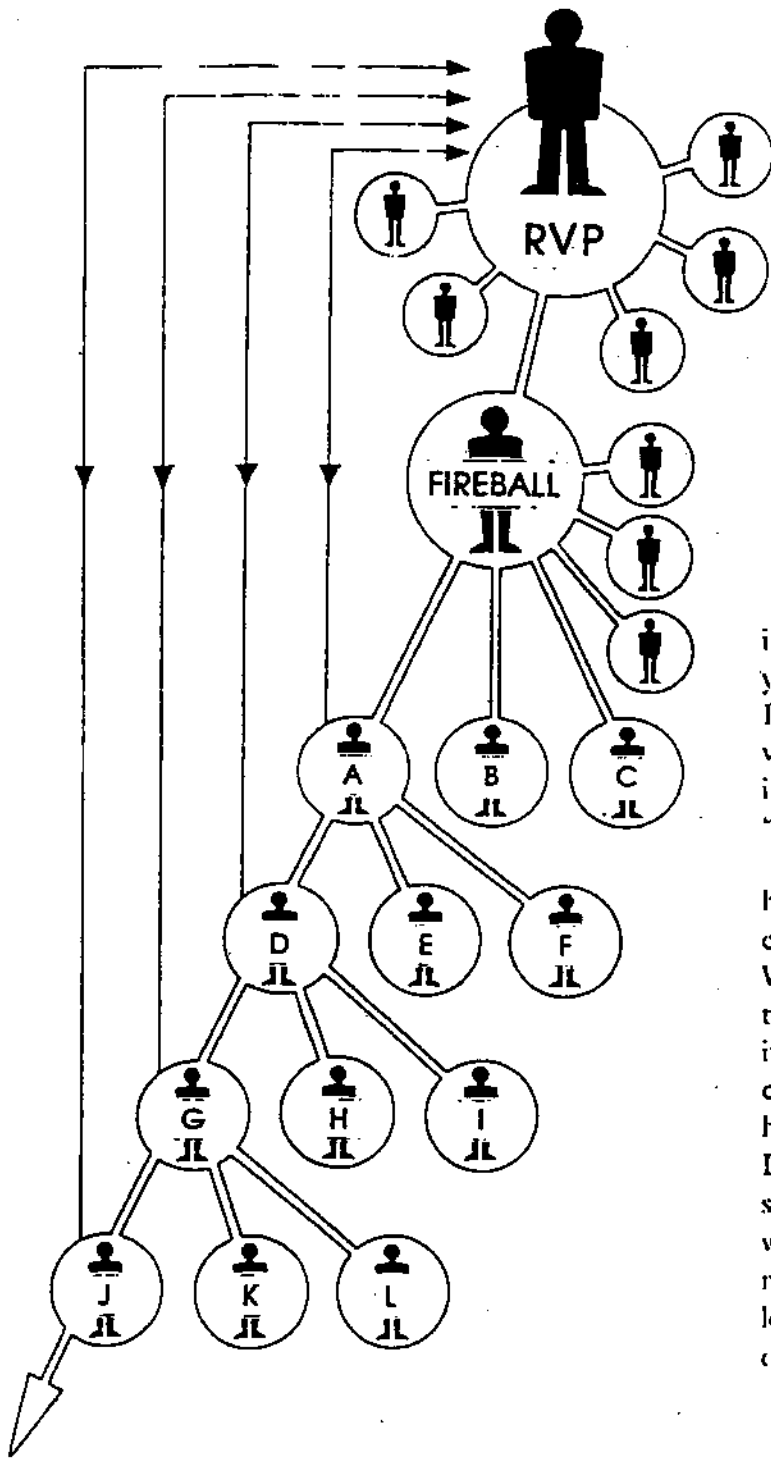

intense. Fireball has a lot of people he knows and wants to talk to. As you train Fireball, you help him interest five or six new people. You find that person A is one of HIS Fireballs. You should begin to work with person A to help him in the business.

## **P**erpetually Producing

One of the key challenges in building through the Super Tap Root system is for your base shop to remain strong and healthy. I see many, many people work and work and work to produce a leader, and once the leader is finally promoted to RVP, they're left in a "weakened condition."

The key to remaining strong and healthy and at the same time, producing leaders, is to "perpetually" produce leaders. When a chicken lays an egg, it sits on the egg to keep it warm until it hatches. Meanwhile, it starts trying to lay another egg. It continually produces. You have to KEEP hiring and training people personally to you. If you keep going Wide, you're going to have someone in your base who is on his or her way to being a leader. You have to adopt the mentality that you're going to have MANY leaders so you have a potential leader developing at all times.

## O verlapping Leadership

The concept of building "Wide" or "Deep" is just a matter of being a good leader. To build a "Super Hierarchy," you must work with people that both deserve and need your help at any level in your organization, not just those people who report directly to you. Treat everyone as if he or she WERE working directly for you. Call them on the phone, help them develop their business.

In addition to your one-on-one work, you should practice overlapping leadership through big group meetings. If you are holding a meeting or a training session, you should realize that people at ALL LEVELS are in the audience. This is why it is GOOD to have big meetings. You are teaching and motivating Deep into your hierarchy.

Only through overlapping leadership, can you identify and develop Fireball leaders at any level.

## D epth Force

In order for the Super Taproot System to work, YOU have to become the "Depth Force" that pushes strength and vitality down through each level of your organization. I like to use the example of a tree's taproot. When I'm explaining it to someone, I draw a picture of a tree and tell the person that the key to the tree's growth is what's in the ground underneath. I draw an arrow to indicate that the tree depends on its tap root for a foundation. The taproot's job is to search as deep as necessary for water and nutrients. In marketing, your "taproot" is a new person you've hired and the people he or she has hired.

What if the root hits some hard rock or bedrock? The root doesn't say, "Tree, I hit a rock. Sorry. I can't get any more water."

Instead, it's going to go through the obstacle, around it, over it, anywhere it must to find what it needs. What happens when you pull a root out of the ground? You'll see there are lots of little roots coming off. For the taproot system to work, it's got to branch out and produce lots of roots.

Nature is the force that drives the system deep. Right now, YOU are "nature" in your hierarchy. It's up to you to be the driving force by doing overlapping leadership. You develop each team until you find a leader who can become the "force of nature."

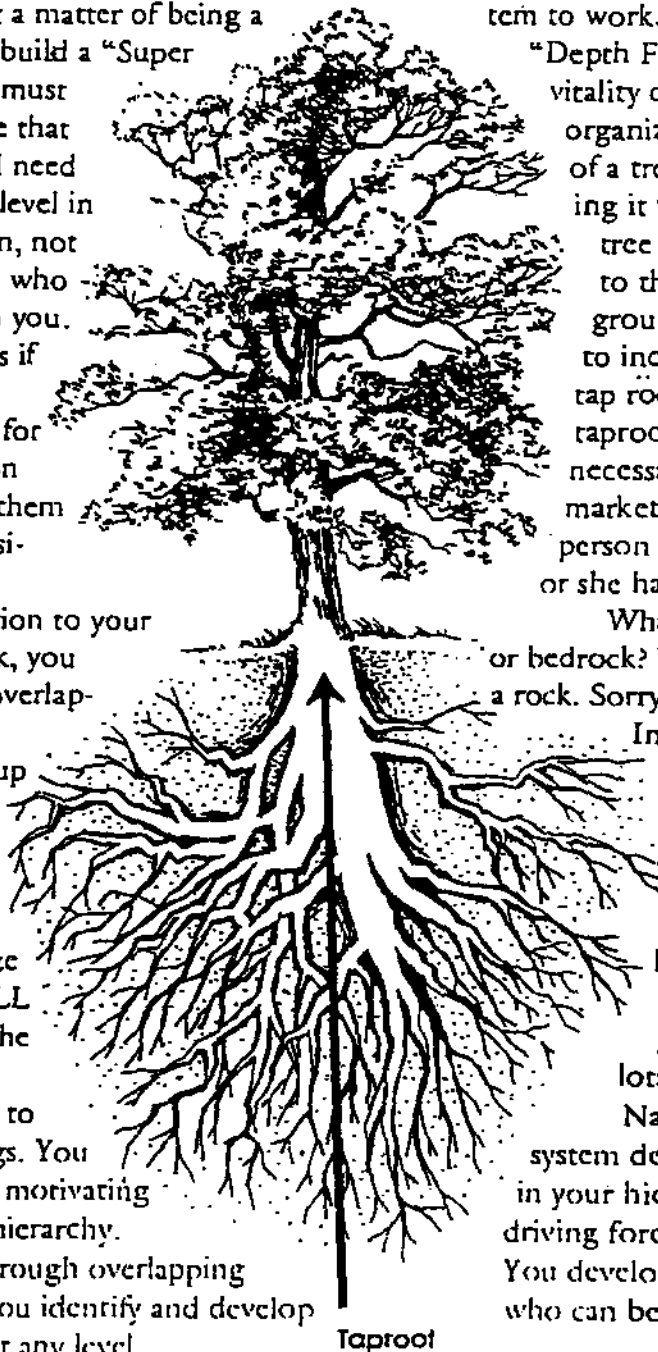



# T

## wo Vitamin Shots to New Recruits

Pictures are so important. Remember: People learn quickly when they have a mental image of what they want to accomplish. I use the following two pictures to make sure every new person understands:

- 1 We're going to surround him with good people
- 2 We're going to surround his people with good people

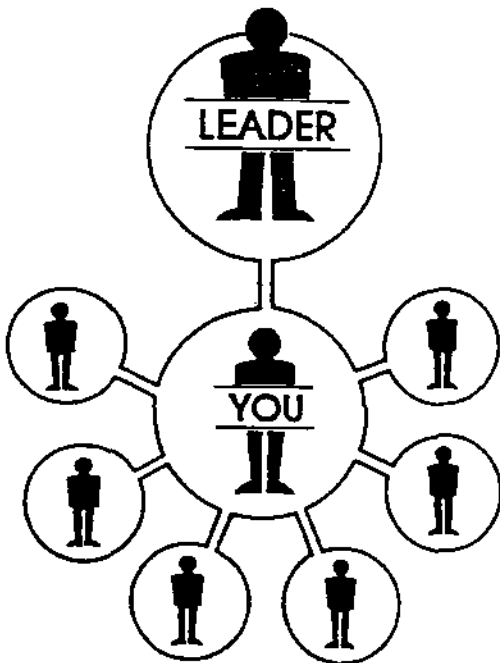

Surround yourself with people -  
Teach How To Recruit and Train

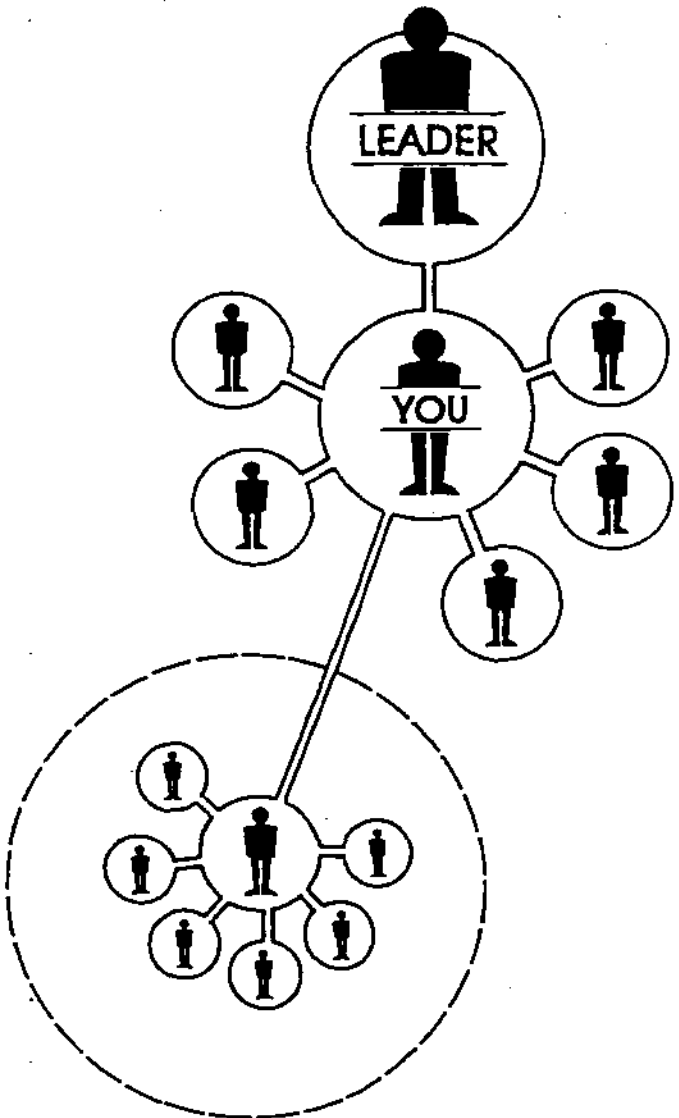

Surround your people with people -  
Teach How to Teach How to Recruit

To accomplish this diagram, the person must learn not only how to interest new people and sell, but how to teach others to do the same. The first things you say to a person are more than likely what he will remember. Explaining this concept to them early is critical. I want everyone to understand what I mean when I say, "You can go out and build your own business." The concept sounds good, but it's actually a foreign thing to most people. The person must understand that, starting from Day One, his RVP is going to help him build a team of people. I tell him, "We're going to help you find and train potential recruits, and you need to watch what we're doing because YOU will be their manager at some point."

After I have emphasized training and team building, I sort of joke with him. I tell him that I'm going to give him two vitamin shots to inoculate him against just becoming a "salesman." And I ask him to play along with me and roll up his sleeve. Then I'll say, "The first shot is a multiplication shot." I explain that developing a team is not just who he knows and what he does, but, "Who they know" and "What they do," and so on down the line.

Then I ask the person to roll up the other sleeve. "This is your Crusading shot." I tell him there are two aspects of our business. There's the great business opportunity that he just got a multiplication shot for, and there's also the Crusade, our commitment to the philosophy of buy term and invest the difference. He will feel inspired by our Crusade as he sees how our products improve the financial lives of his friends.

## How Many Can You Spin?

To build a Super Hierarchy, you must work Deep and Wide all at the same time. You are supplementing your width through in-depth tap root work.

The minute you find and develop a leader, you don't stop taprooting. You just have more time to build Wide. All the while, you rest as you go. You'll identify the more ambitious ones and be able to "tap root" through them.

It reminds me of those old traveling Chinese acts. I remember the first time I saw them on the Ed Sullivan Show. The leader was a big hit when he could get 20 plates spinning at once. I saw the same outfit about a year ago and he had 50 plates spinning!

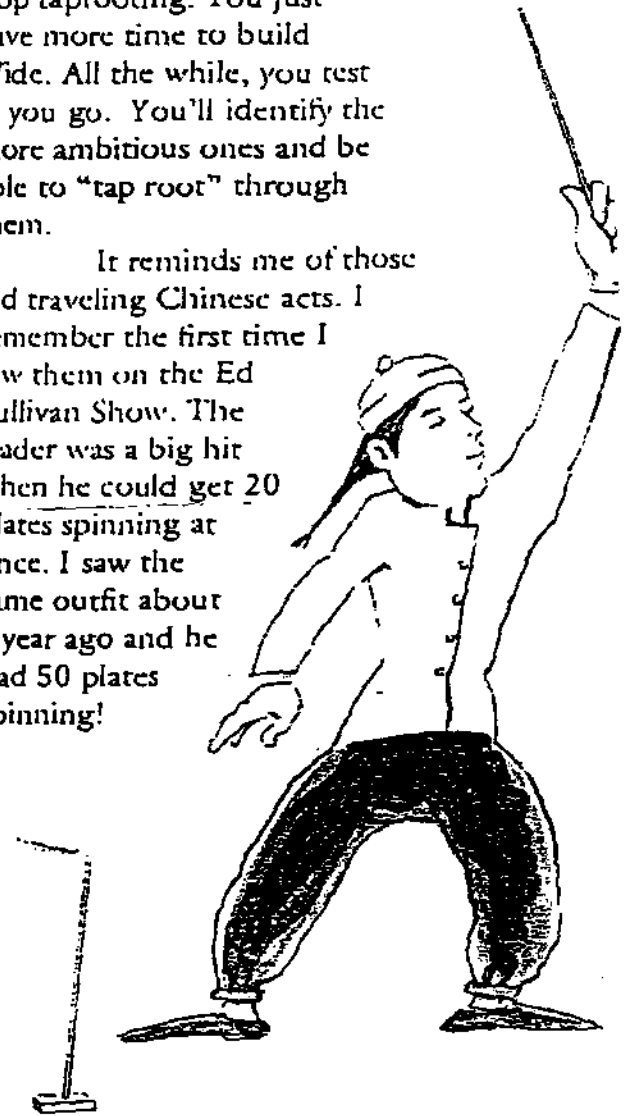

A lot of people make the mistake of getting a few new people going, then stop. They build an organization, but they don't build a Super Hierarchy. These are usually the people who don't want to work that hard. You see, there's only one hangup about building a Super Hierarchy, you don't get to sit back and kick up your heels and watch your hierarchy grow. It takes work.

---

**ALW LEADER PRINCIPLE**

---

Leaders always put their people before themselves. If you want a successful business, your people must feel that you're working for them. Your most important job is helping them to become the best they can be and reach the absolute peak of their potential. Do that, and your business will take care of itself.

---

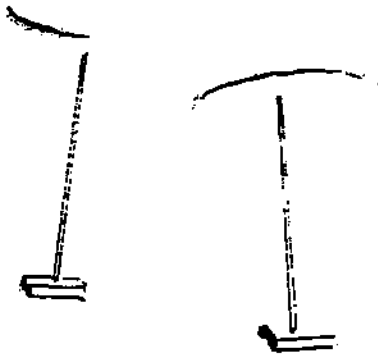

# The Magic Of Compound Recruiting

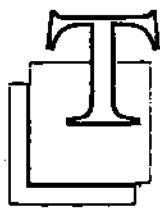

## The Magic of Multiples

This book is named after this chapter because I think it's one of the most intriguing concepts found in marketing. "Compound Recruiting" is based on the mathematical principle of "Multiples."

Let's assume, for the moment, that to get a hierarchy started, you must recruit and train at least two people. If each of these two people recruits two, then you have four, right? The chart below is a multiplication

EACH RECRUIT		2
		2
	X 2	4
LEVEL 1		4
	X 2	8
LEVEL 2		8
	X 2	16
LEVEL 3		16
	X 2	32
LEVEL 4		32

table showing how many recruits you could have at each level, if every new person recruited and trained two new people. If you can do even an elementary level of math, this is probably nothing that will surprise you.

Now let's work the Multiples again, assuming that you will start out by recruiting and training THREE people, and each of these people will then recruit three people. As you can see in the chart, by the fourth level, there is a SUBSTANTIAL difference in the number of people. What is interesting, however, is that the real DIFFERENCE was only ONE person at every level! That's the "magic" of compound recruiting. Some people have a hard time seeing themselves recruiting hundreds of people. But nearly EVERYONE can see themselves recruiting two or three.

EACH RECRUIT		3
		3
LEVEL 1	$\times 3$	9
LEVEL 2	$\times 3$	27
LEVEL 3	$\times 3$	81
LEVEL 4	$\times 3$	244

When I'm showing people this "magic," I like to get their attention by asking them the difference between two and three. Of course, they always reply, "One." And I say, "No, it's really 244!" Then I show them what I'm talking about by working the two charts through four levels.

### Formula for Failure

Now what happens if you don't recruit anyone? Will you be able to build any kind of an organization? Look at the following chart. If you recruit zero and each one of them recruits zero, what have you got? Zero. What happens if you keep duplicating zero four levels? You've still got zero. Now, this may sound like a joke, but unfortunately, it's a very real picture of what most people do.

EACH RECRUIT		0
		0
LEVEL 1	$\times 0$	0
LEVEL 2	$\times 0$	0
LEVEL 3	$\times 0$	0
LEVEL 4	$\times 0$	0

What if you recruit and train one person? In the next chapter, we talk about the power of "One" as a means of building a sizable team. But there's a big difference in recruiting one person personally and in recruiting several people personally. The Power of One can help get you STARTED, it can help you get a team going, but it can't build a Super Hierarchy.

EACH RECRUIT		1
		1
LEVEL 1	$\times 1$	1
LEVEL 2	$\times 1$	1
LEVEL 3	$\times 1$	1
LEVEL 4	$\times 1$	1

Still, some people will recruit one person and forever work Deep as they train their new recruit. What happens? Looking at the next chart, we see that one times one is one. And one times that one is still one. You take it four levels, and what do you have? You've still got one. Now, you may say, "But it's not the same thing!" I say, in the real world, that it IS the same thing. Why? If you recruit just one person, and he recruits one person, and the next guy recruits one person, then you're not likely to build anything. It's only natural that some people are not going to work out. Either they don't "want to" bad enough, or it's not the right time, or whatever. You have to remember that unless you are able to find and develop a Fireball leader, the COMMITMENT of each level gets a little weaker. (As a single person, you can only work with a limited number of people at once.)

I see a lot of people who think, since they're working with one good recruit, they've got something going. They're kidding themselves. If you're going to make this thing go, you've got to recruit and train at least two.

## **T**he Magic of Geometric Progression

In earlier chapters, I have mentioned that building Wide is building by addition. If you hire three people personally, your hierarchy will be a total of four people. Yourself plus three. If you build Deep, you are build-

ing by multiplication. If you hire two people, and you work with those two people to each build two, you now have four people downline. If they each build two, then you have eight.

You achieve "Geometric Progression" when you find a leader downline who can do exactly what you are doing. In other words, you are looking for someone with the interest and the motivation to go out on his or her own and hire and train and build an organization.

The chart on the next page shows how – through Geometric Progression – you can build a large team in a relatively short period of time.

Let's say that initially you're going to go out and get three new recruits. Your priority is to help each of those people build three new people. Soon, you should have 12 people on your team. You and your team must now work with those 12 new people to get them three new people each. You are following the same pattern, working through your leaders to see that each person recruits three new people. If you follow this principle, soon your recruiting numbers will mushroom because of the magic of Geometric Progression.

Obviously, the only way this whole configuration can occur is if you have identified and duplicated leaders at each level. You can't do it all yourself. Hopefully, approximately half of those you recruit will be serious people who will emerge to assume leadership positions to help your hierarchy grow.

This is not some pie-in-the-sky formula. This "phenomenon" has literally

C H A P T E R S E V E N

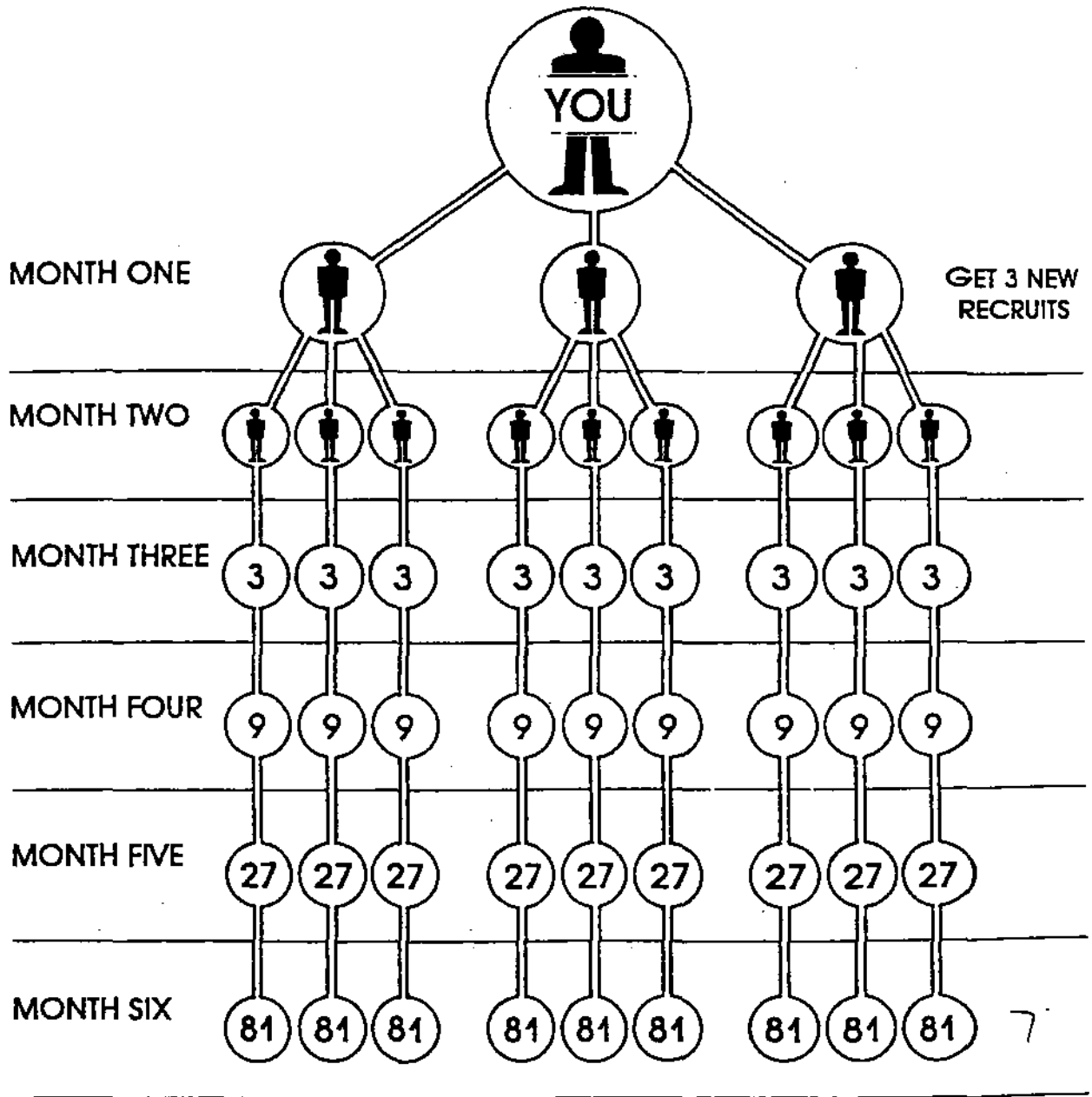

happened to me. When I moved my family out to Denver, Colorado, I recruited and trained 12 people in my first 30 days. Five of these people became RVPs. Three of those RVPs became what I would call "strong" RVPs. By the end of six months, my team and I had more than 1000 people recruited and trained.

It IS possible to build a tremendous hierarchy, even in six months. You simply have to catch the VISION of Geometric Progression.

## The Mystery of the Multiples

I have always believed in showing people the magic of Multiples very early – as you are trying to recruit them. I'm not sure why, but people are always intrigued by the compounding effect. I even find that professionals and people with the most education are the ones who are the most excited by a recruiting presentation that shows the power of big numbers.

Too many people make the mistake of leaving out the Multiples when they are trying to recruit someone. Some people never even hint at it, or if they do, it's the last few minutes of a recruiting presentation. You can't sell the "big picture" of the marketing opportunity if you never talk about the power of large numbers. Remember one of your goals in recruiting: you're looking for people who want to make extra income. Someone with an entrepreneurial spirit is going to be VERY interested in our management opportunity!

## The Popcorn Effect

Multiples are exciting. They stretch your VISION. But you must remember that it takes TIME for the compounding laws to take effect. Art Williams says you have to expect the first 18 months to be a disaster. He says that the first 1-3 years after you begin your big building effort are nothing but a game of survival.

Think of it like popping popcorn. You put some kernels and oil into a pot. Then you put it over a hot stove and sit and wait for something to happen. I don't know about you, but every time I've ever popped corn in my life, I've always gotten impatient and wondered if something was going wrong, and I've lifted the lid to look inside. Usually, all the kernels will be sizzling in the oil and one of them will pop and hit me right in the face. Then, at first slowly, they will begin to pop. As you shake the pot a little more, they pop a little faster. After a few more minutes, they are popping like mad and you are wondering if the pot can hold all the kernels you have used!

The Multiples in any business work the same way. Don't get discouraged if your base shop drags the first few months. Keep building, knowing that if you continue to work, the Multiples will begin to work their magic!



# B uilder's Path to the Top

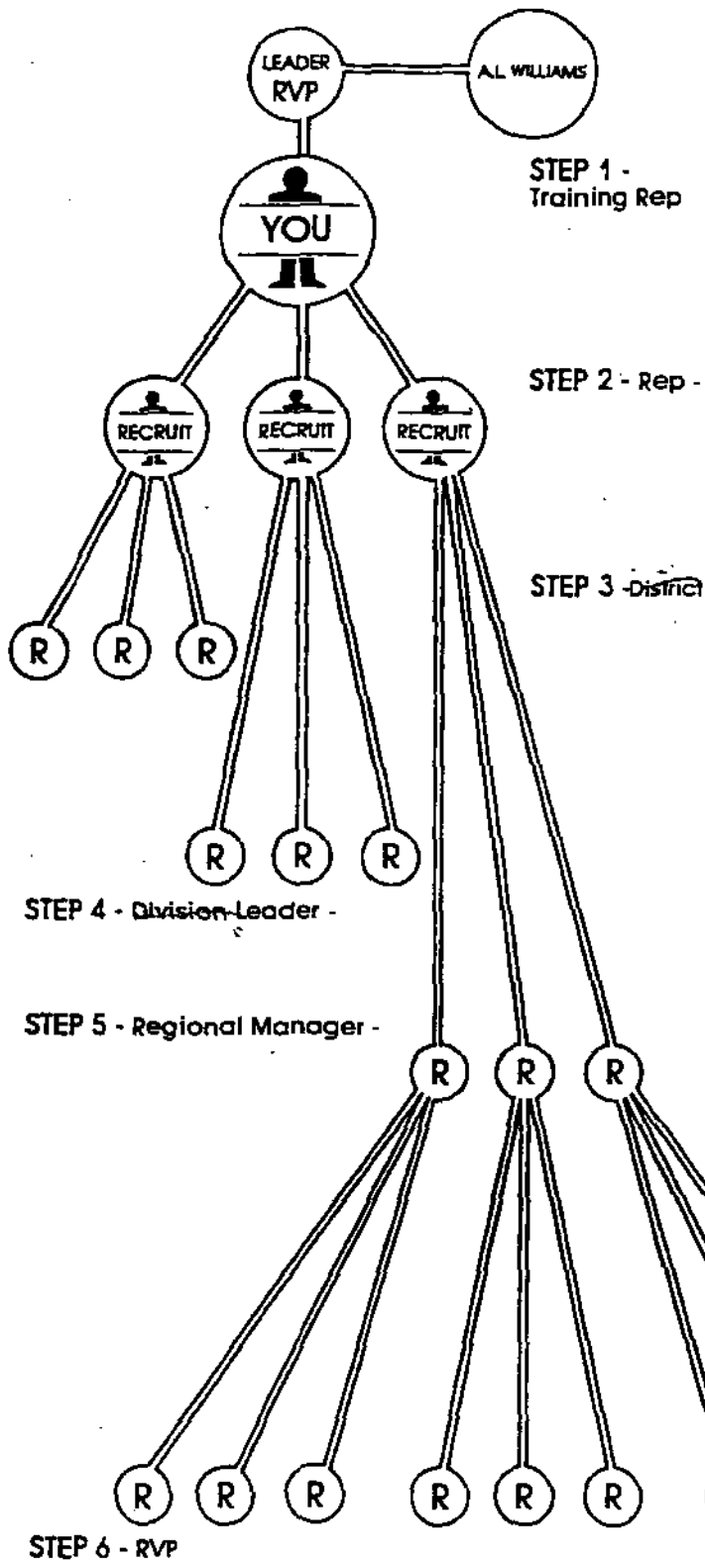

In Chapter Two, "A Builder's Mindset," I discussed the importance of building a team for each new person. I said that you should adopt a mindset of "get them in and get them some recruits," and in doing so, you will "get them trained." You can use this mindset and the concept of Multiples to help you earn promotions to new commission levels. For example, if you want to get to RVP, whatever the current guidelines for earning a RVP promotion, you should always FOCUS on recruiting, training and building a team - AND building your recruits' teams.

Depending on the current guidelines, I map out a configuration of how many you need to hire to get to a certain promotion level. For example, if the guidelines require you to hire three people who are each field trained on three sales, the tendency is to do just that. Field train each person on three sales. I think another way. I suggest that instead of just trying to get them three field training sales, you should try to get them three new recruits. Then, you will actually accomplish both things.

The fastest way I know for a person to get trained is to go with his or her RVP and watch the RVP show the asset management and marketing opportunity presentations to three people. They may or may not buy. More than likely, they will if they need it. This way, not only do you make training sales, but you have the beginnings of a team. And the fastest way to get those three recruits trained on

the required number of sales is to build three recruits. Now you're aiming at RECRUITS and hitting SALES. You've got production going, but your No. 1 goal is to rapidly build a team.

I see too many people who get out there and sell themselves into a promotion. There's nothing "wrong" with that, but they have to realize that every morning they wake up, they're still going to be "unemployed." They're totally alone in earning income. The only way to maximize the management opportunity is through building your company. Until you do, you are just a "salesman" constantly worrying about your next paycheck. Think of everyone as a potential member of your team. The chances are you will earn promotions and build a team in the process.

---

**BUILDING PRINCIPLE**

---

If you want a business that lasts, build with quality. Never let your desire for rapid growth take the place of your common sense. If a leader gets lazy about recruiting, he will find himself with nothing more than a bunch of warm bodies and a million problems. Recruit people who have a burning desire to win.

---

## The Power Of One

### **T**he “No Excuse” Formula

Over the years, I’ve talked to a lot of people who’ve come on board with me and complained that they just can’t work “big numbers.” “I can’t talk to anyone.” “I’m no good at building.” These are just a few of the excuses people throw out when they try to explain why they have a “little” organization.

What they don’t realize is that even the world’s worst “dud” can still build a sizable business. All it takes is a strategy I call “The Power of One.”

The Power of One is based on the theory that even though you may be weak at recruiting, you are probably still going to be able to hire and train at least one good person. I’ve never met anyone yet who couldn’t find at least one.

Let’s assume that you have hired someone. We’ll call him or her “A.” You may think, “Just one is not going to get me anywhere.” That’s where you’re wrong!

Now that you’ve hired “A,” what is the fastest way to make three sales? Go out and find three people personally to sell to, or

go field train a new person on three sales? For someone who has a hard time meeting others, the second choice is usually easier (it’s also easier for the person who has little or no “warm market”). So schedule a night on your calendar to go out with A and see people in his or her warm market. If you schedule it for early in the week, say, Monday, you position yourself to have activity for the entire week.

On Monday, you go out with “A.” Let’s say out of several people that you visit, you wind up hiring for A at least one person, “B.” You have just positioned yourself for an additional three sales, since you are now going to also be field training “B.”

#### BUILDING PRINCIPLE

Building personal relationships requires unconditional commitment. Your people will love you if you are there for them when they need your help the most. And when you’ve lost the faith and trust of people on your team, you’re worthless as a leader.

Now pick a day on your calendar to devote to B. According to the chart on this page, you would pick the soonest possible night, Tuesday. You're going to go out and begin to field train B, but for sure, one of your main objectives is going to be to get B a new person. Now, you've got things going. You hire "C" as a potential member of B's team, out of B's warm market and set up a day to go out with C. Your objective is to train C and find him potential members for his team. You are helping each of your new people by field training them and building an organization for them. You have set up a continuity in building.

By always getting a new person at all levels just "one" new person, you always position yourself for at least four more sales. AND you have the potential to have a Fireball leader pop up. Remember, you never know who that next person will be. He could be a real Fireball waiting for your opportunity. If he isn't, don't let it hamper you. You don't have to worry about getting "Super Man." You just have to have at least one person.

Even if you never become super Wide, if you follow the procedure for "The Power of One" over a period of a few weeks, you will become five or six Deep. Every one of these people are technically reporting to you. In a sense, you are Wide, even though you went Deep. Plus, you have that "team feeling." It makes no difference whether they came in a straight line or not. These people are the nucleus of momentum.

For people waiting for some great revelation to make them a great builder, I have one thing to say, "All you have to have is 'One.'"

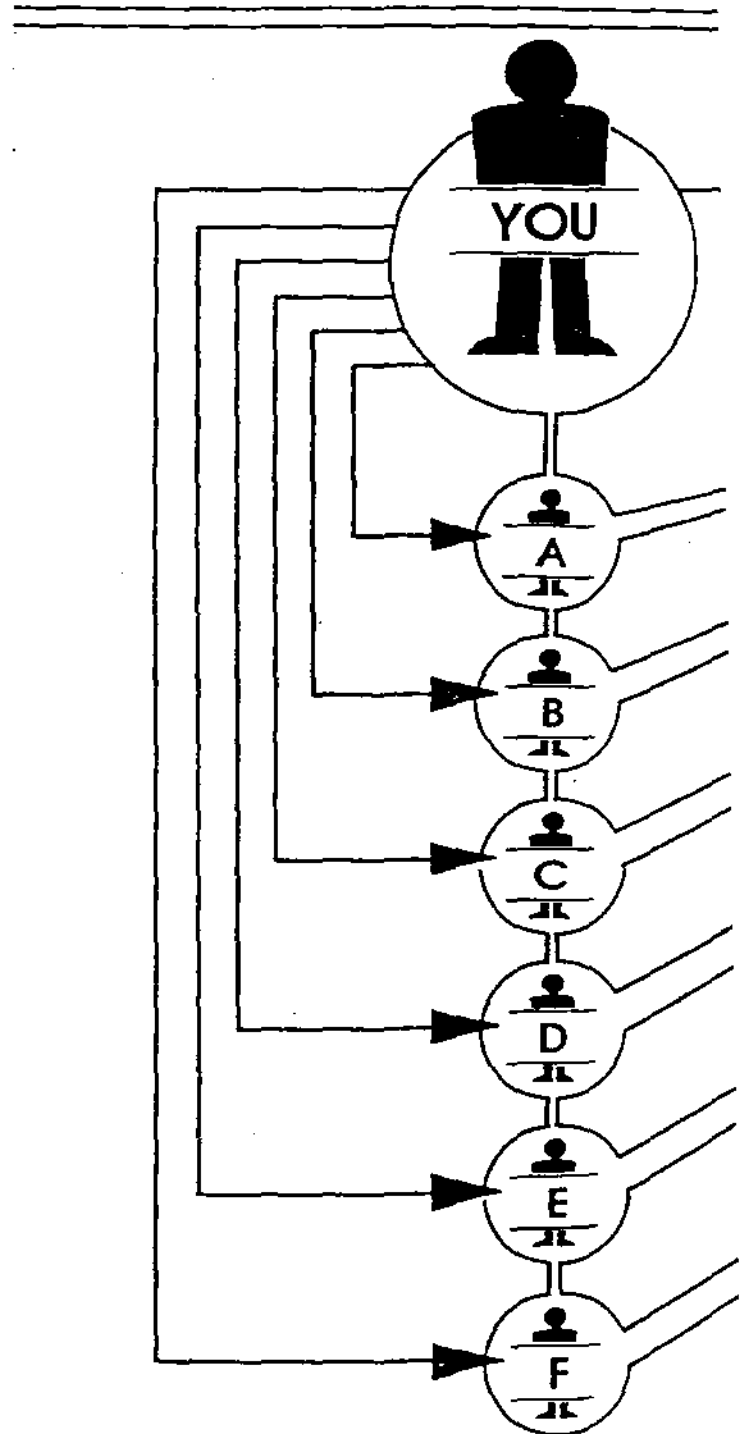

# THE POWER OF ONE

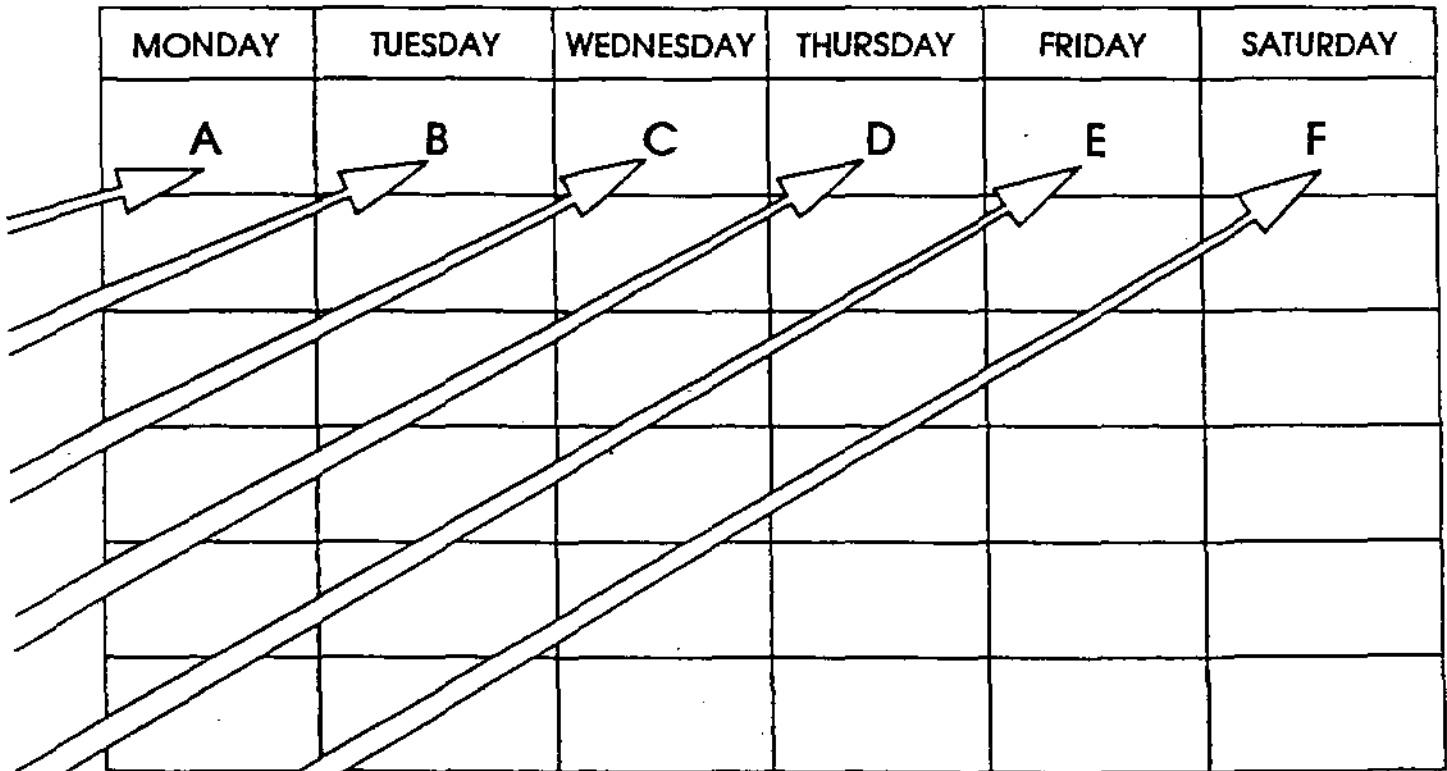

## POWER POINTS

By always getting your new recruit at all levels just "one" recruit, you position yourself for at least 4 more training sales and a potential new "Fireball" leader.

By scheduling each new downline recruit a specific night on your field calendar, you can go 4 to 5 deep in 7 to 14 days easily!

The probabilities are greatest that each recruit, whether strong or weak, can recruit at least one person

## A Recruiter's Mentality

### **P**rofile of a New Person

By now, you should have picked up on one of the most important concepts in this book: adding new people to your team. If you're going to be a builder, you have to think "opening new outlets." The biggest question for most people is "WHO do I contact?" In Chapter 1, I said that you should look at everyone you meet as a potential hire. That principle still applies. You cannot prejudge people. I don't care how long you've been in this business, you NEVER know how a person is going to react to a business opportunity until you show it to him or her.

Recruiting is an all-time thing. It is a "state of mind." You should decide that everyone you meet has potential until proven different. When you look for quantity, you get quality. Remember that the "Law of Averages" comes into play in this business. You're not going to sell everyone you try to sell. You're not going to interest everyone you try to interest in your business. NO

ONE bats 1,000, it doesn't matter what kind of a business you're in. To be profitable in spite of the "Law of Averages," you have to apply the "Law of Numbers." If you're looking for teachers and coaches, you've got to talk to a lot of them!

ONLY after you have adopted a true builder's mentality are you ready to apply some very basic principles that will save you from the dangers of indiscriminate hiring:

**STOP** looking for people who want to "sell."

If the name of the game is hiring and training, why would you want to hire a bunch of people who were more interested in making some sales than in building a team? (Remember that sales will come as a natural result of hiring, training and building a team). These people will usually focus on the "wrong" questions when you're interviewing them.

**2** START looking for people who want to earn extra income.

These are the future "Fireball" leaders and future Super Hierarchy builders. They are people JUST LIKE YOU. They are usually frustrated because their present job won't allow them to become financially independent. They're DYING to become their own boss. They have a BURNING DESIRE to be "Somebody."

**3** Hire people who WANT the opportunity and beware of those who NEED it.

Anyone looking for a "Get Rich Quick Scheme" should send up a BIG RED FLAG in your mind warning you not to hire them. People who are desperate are dangerous for several reasons. Most of the time, they are people who can't handle money properly or don't know how to treat people right. There are ONLY a FEW exceptions to this. If you are considering someone who is "desperate," be sure you know them and their particular situation WELL. Sometimes, a person may have worked hard all his or her life, but circumstances beyond their control created tough times. These people are usually hard workers who only need a chance to straighten themselves out. They make EXCELLENT additions to your business. Just be sure you know the DIFFERENCE.

**4** Be selective

Target some select group of people you can relate to. These are people who will listen to your personal story about why you went into your business and can identify with

your reasons. One ex-policeman I know started by talking to other policemen. I started by talking to other people on the railroad. Look around you at the people who are LIKE you. They're your best possibility.

**5** Look for "Five Pointers."

Look for new people who fit these five "points":

Age ~~25 and up~~ 27-35

Married

Children

Employed with \$15,000+ income

Own a home

**S**ell the Dream and Crusade Simultaneously

Approach every prospect about your marketing opportunity from the BEGINNING. There is a whole school of thought that says sell-sell-sell and only after you've clinched the sale do you talk to your client about joining your business. There's no doubt that this works for a lot of people. But I personally think you risk losing a potentially good person by using this method.

I have some friends right now who live in Macon and will never get in this business because I sold them insurance back in the early days when all I did was sell. Their total perception of me to this day is "Hubert the Insurance Salesman." It

↓ Teach the Team to Sell the Dream & Crusade

doesn't matter to them how much money I make now, what kind of car I drive and the fact that I own an airplane from money I earned. The Opportunity doesn't interest them because the very first impression they had of my job was selling insurance. And if it involves "life insurance, sales," you can bet people don't want to be a part of it. Remember, by human nature, most people can't see themselves in "sales."

If I had gone in there and talked to them about a business of my own, and how much I was earning in extra income, and then showed them what I did to make that extra income, they would have looked at it in a whole different light.

The way to sell the marketing opportunity and the Crusade simultaneously is to always tell your own story. Tell the prospect how you got involved. This will show him how you were turned on by the Crusade. Don't be so anxious to make the sale that all you do is pick up their policies. People blow it when they go in there and they talk about all the facts and figures of our products and nothing else. They sound just like salesmen. It completely destroys the magic of the marketing opportunity.

The very first time you talk to a prospect, you want to be able to assess his or her reaction to the business opportunity you're offering. Are they intrigued by what you're saying? Do they want to hear more? Do they want to come to a meeting?

When I go in a home to talk to someone, I form a mental picture of two buttons:

- 1 Entrepreneurial Dream Button
- 2 Client Button

If I go in and hit the Client Button first, it doesn't necessarily trigger the Dream Button. But if I go in there and hit the Dream Button, first, I STILL have a GREAT chance of trig-



gering their Client Button, too. You've positioned yourself for a WIN-WIN situation.

When Ray Kroc first met with a group of prospective franchise buyers, he wasn't in there most of the night explaining how they made hamburgers and French fries. He talked about how their dreams could come true if they bought a franchise. Before it was all over, he said, "By the way, try these hamburgers and French fries. How do you like them? Can you see yourself buying them?"

Anyone thinking about buying a franchise or buying a business from someone is naturally going to study the business and learn how it works. They have to, to find out whether or not it would be something people want and need. You can't expect to build a successful business on a foundation of sand. But don't focus on this. It's NOT the "Magic." Magic is created when you show that prospective entrepreneur how he can make his dreams come true.



## Become a Student of Human Nature

Most people who are expert deer hunters have studied the animal for years. A good deer hunter has to be able to predict how the deer will react to any given situation. Then, he does everything in his power to make sure all the elements of the situation are just right.

In recruiting, you have to understand people. You have to know what turns them "on" and what turns them "off." You have to take their feelings into account. Consider these ten points of human nature:

- 1 They're quick to jump to conclusions.
- 2 They're skeptical - they suffer from the "shaft" syndrome.
- 3 They procrastinate - the spirit is willing but the flesh is weak.
- 4 They dream of great wealth.
- 5 They're curious.
- 6 They don't think they can sell.
- 7 They don't like insurance salesmen.
- 8 They would like to be their own boss.
- 9 They would like to have a business of their own, BUT...
- 10 ...they all doubt that they ever could or would.

## The Ebb and Flow

You should never come on too strong or be overly anxious or eager when you're trying to introduce someone to your business. I've had people come on this way when they're trying to sell me something, and a big warning sign begins flashing in my head and I get the feeling that the salesman is really desperate.

Be confident in what you are doing, knowing that the numbers will work for you. "This ain't just another deal" is one thing I say when I'm showing the opportunity to someone. And if a person wants our business, he will take it. If not, move to the next person. By withdrawing, you will find that a lot of good people will realize that you really and truly have something great and you are going places with or without them. This is what I call "Pull Power." Pull Power is a magnetism that draws people to you.

Be enthusiastic! It's contagious. And don't be afraid to show your feelings, especially about the Crusade. People understand and respect the commitment.

Think and act like a quarterback. Look at Dan Marino, pro quarterback for the Miami Dolphins. He's the leading passer in the history of football. Marino plans practically every play to be a touch-down bomb.



meaning his team will score. When he goes into the huddle, he tells his guys the play that he's going to call to make that touchdown pass. Then they break the huddle and he goes to the line. If he looks around and sees the defense is stacked against him, he calls an audible and checks off. Then he hands off to the running back to gain at least 3-4 yards.

Every "play" you call should be designed to interest the prospect. If you read his reaction and decide that he's just not going to be interested, then your "audible" is to make the sale.

## Sell the Dream/Build the Team

Whenever I'm asked, "What do you do?" I've always said, "I replace full-time nightmares with part-time dreams." I want to build a team of people who want their dreams to come true. Not only that, but I want to train them to build their own team of dreamers.

When you're talking to someone one-on-one or at an Opportunity Meeting, the essence of selling the marketing opportunity is to get that person to think, "I can do that." Whatever I'm telling them, I want them to see themselves as ME. And the BEST way to get them to say those little words is to SHARE YOUR STORY, your personal testimony. When you do this, you trigger their imagination, no matter how humble your origins. No matter whom you are talking to, the spark goes off and their motor starts running. You've cranked up

their "Dream Machinery."

I have people in my business bring people to my office every day to meet me and all I do is tell my story. I spend 5 or 10 minutes talking to them about how I got started and what it has meant to me.

## The Magic of Compound Dreaming

Before you can experience the "magic" of Compound Dreaming, you first have to have a dream. Then, the split second that it becomes obvious that your dream can really come true, you must dream a new one. New dreams keep you from reaching a plateau and becoming stagnant. You just keep pushing and before you've even accomplished your first dream, you're already on to the next one.

Compounding really starts to take effect when you amass a tremendous team of people who want to achieve their dreams.

When I'm talking about the "Dream" don't misunderstand me by thinking I mean joining A.L. Williams. That is NOT the Dream. Nor is money the Dream. The Dream is what money and achieving financial independence will allow you to do. When I worked on the railroad, if they would have sent me a paycheck without working, I would have stayed home and taken every one of them. There are people out there who are trying to get people excited about "joining" for the sake of joining something. But you can't sell that to most people. You CAN sell the Dream of what they would be able to do if they were financially independent.

# A System Whereby Building Never Stops

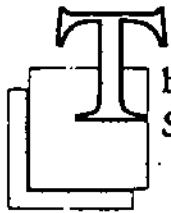

## The Hold-A-Meeting System

I remember one of the first meetings I ever held. It was two o'clock in the morning on a caboose at the back of a freight train going 55 mph. between Macon and Columbus. I had the extra-board flagman on the job with me. We were sitting in the cupola of the caboose, and I told him I wanted to draw out something

that he would be very interested in. So he brought his lantern over and I had mine and we hooked them under our arms and shone the beams on the top of a cardboard fuse box. Then I drew out plans for building a marketing business. That was my first meeting.

The point behind this story is that to continually be building, you must be constantly "holding meetings." A meeting is any place where two or more people are gathered.

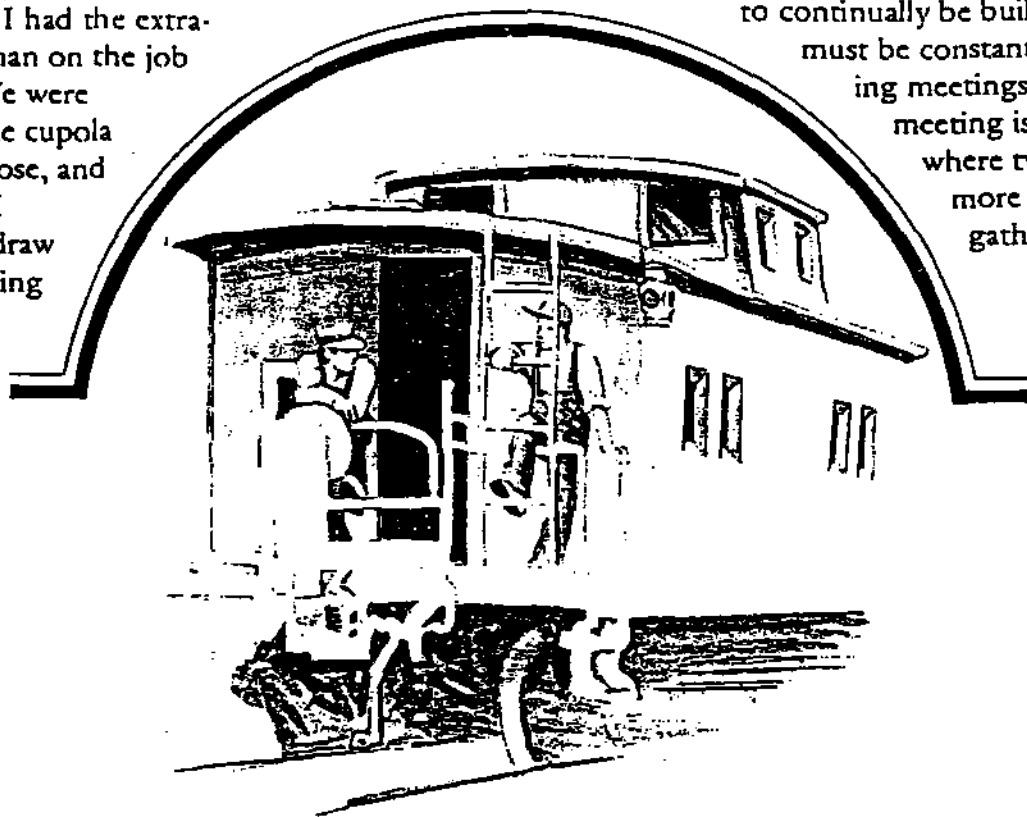

## **T**he One-On-One Opportunity Meeting

This is the most important type of meeting to hold. As in the previous example, you only have to have one person as your audience! To build a Super Hierarchy, you should be having these types of meetings **ALL THE TIME** – a minimum of four to five days or nights per week. The result of this initial meeting will be to get a commitment to come to your Opportunity Meeting at night.

- WHO?** Friends, neighbors, relatives, co-workers, social contacts, business associates
- WHAT?** Focus on your business opportunity, supplementing with graphics. Sell the Crusade by telling your story.
- WHERE?** Home, office, restaurant, work, any where where two or more are gathered.
- WHEN?** Breakfast time, mid-morning, lunch-time, afternoons, dinnertime, evenings – anytime and all-the-time! – 4 - 5 days/nights per week.
- HOW?** With Enthusiasm and Emotion.

## **H**ow to Present a Dynamic Opportunity Meeting

In the beginning of this book, I stated that one of your primary goals in building was to get more and more people, both “old” and “new,” to your Opportunity Meeting.

I believe that the Opportunity Meeting concept lies at the very heart of a successful business. The more people you have at the meeting magically has a direct effect on the amount of sales produced by your base each month. Remember the formula:

$$\begin{array}{l} \text{Average No.} \\ \text{of People} \\ \text{Per Wk at} \\ \text{Opp Mtg} \end{array} = \begin{array}{l} \text{Average No. of} \\ \text{Base Shop} \\ \text{Sales Per} \\ \text{Month} \end{array}$$

It's no wonder that it's essential to have good meetings!

The Opportunity Meeting is also designed to **RE-MOTIVATE** your existing team. Remember that these people have already come to work and been trained and stand ready as your natural resources, don't ever “count them out!” The secondary purpose of the meeting is to sell the Dream to new recruits. You always want to show “bigness” and stability in your presentation. Have a minimum of one meeting per week that lasts one to one-and-a-half hours. I think the best night is Tuesday. Larger base shops will hold two meetings per week. Every Tuesday and Thursday night would provide the proper momentum.

# P reparation

This is **CRITICAL** to the success of your meeting. And the most important part of your preparation is to make sure you have as many people as possible! I use an Opportunity Meeting Projection Sheet. Everyone in my base shop fills this sheet out every week. Administrative people call to confirm reservations and to encourage those "old timers" who have not signed up to come. Even if a rep hasn't been to a meeting in two months, he gets a phone call. When you call these people, make them feel good even if they've been "missing in action" for a while. Let them know that you're counting on them to be there to help with the new people. **ALWAYS** do a Projection Sheet. If you don't prepare to have a good meeting - you won't!

Plan to hold your meeting at your office or a meeting room. In the first half of my meetings, I require slide support equipment and in the second half of the meeting I use a grease board to show marketing plans.

**ALL** meetings should start promptly at 7:30 p.m. and conclude no later than 8:45 p.m. (1 hr. 15 mins. - max) regardless of who or how many in attendance.

OFFICE ADDRESS		DATE		POSSIBILITY PROJECTIONS FOR	
				NEXT OPP. MEET. ON	
NAME	ADDRESS	DATE	STATUS	DATE	STATUS

**BEFORE** the meeting, all "new" people should:

- 1 Have been advised that our business opportunity will be highlighted.
- 2 Preferably have been driven to the meeting site by the ALW Invitor.

**EVERYONE**, both "old" and "new" people, should:

- 1 Bring their spouse if at all possible
- 2 Have been exposed to good, strong leaders with a positive winning attitude at all times.
- 3 Be registered in the attendance book (for future records) by their ALW friend and given a name tag highlighting their 1st name in **BOLD** print.

NAME		ADDRESS		DATE		STATUS	
NAME	ADDRESS	DATE	STATUS	NAME	ADDRESS	DATE	STATUS

- 4 Be properly introduced to the speakers for that night, so that a warm rapport can immediately be established.
- 5 Be made to feel at ease and properly seated in Opportunity Meeting area.

## **T**he Magic of Crowds

Your entire presentation should be **DYNAMIC** and **POWERFUL**. It should be conducted by the most enthusiastic and dynamic **"DO IT FIRST"** leaders on the team (preferably two leaders share speaking on pre-assigned portions of agenda to provide balance).



If you don't have the most super-duper speakers in the world, **DON'T LET THAT STOP YOU**. You can **STILL** have a **GREAT** meeting. There is great synergy at work in groups. I call it **"The Magic of Crowds."** A large number of people creates a

sense of urgency to get in and get going. People are more relaxed because they sense that you aren't going to "bug 'em" or "beg 'em." Everyone involved is excited and enthusiastic. This is contagious!

A business friend of mine visited a friend of his recently. This guy has a booming business, and people always go to see the guys who are "hot." So he goes to see all this "magic" that is happening in his friend's business. When he finishes, the first guy says, "I give a better meeting than you! Why are you doing so much better?" The second guy says, "I never claimed to give a great presen-

tation. The only difference between me and you is that I've got 300 people listening to me and you've got 30." The success of an opportunity meeting is determined by the number of people in attendance.

I believe it's really impossible to give a "bad" presentation if your message is great. So stop worrying about your delivery and go for it!

## **T**he Presentation

During the presentation, your speaker will portray the following:

- No pressure! (Even a little "laid back")
- Sincerity and conviction
- Stability of company
- Crusade/work (no something for nothing here!)
- Unlimited opportunity/challenge
- Freedom with responsibility
- Believability - they must see themselves winning

No **HYPE** is needed in your presentation - the facts are already good enough (let this goodness show) Don't oversell! The infectious enthusiasm of the ALW friend is the key element in the new person, not the size of the office, the eloquence of the speakers, nor the impressive slides, videos, posters, etc.

**S**uggested Opportunity Meeting Agenda



**A**

Welcome Guests/Introduction of first speaker (first impressions are the most important!)



**B**

Get guests to dream/ponder goals -(Prime Pump by relating your reasons for going into business).

Point out reasons that most Americans have a feeling of HOPELESSNESS such as INFLATION - Job Ceilings - Lack of Experience - Lack of Capital, and/or Fear of Job Security Risk that prevent them from "Being in Business for Themselves."

Describe how your business allows you to "be your own boss" with a "business of your own" - You start part-time usually with less than \$100 regardless of your experience level if you're ambitious and honest.



**C**

Tell how you started.



**D**

Give good CRUSADE - oriented presentation relating:

Flaws of cash value life insurance.

Funny banking rules.

"Buy term and invest the difference" concept (Asset Management Concepts brief).

The Decreasing Responsibility theory. "How to Increase Your Net Worth" presentation.

Why mutual funds?

Why we're controversial.

Why we are RIGHT

If they don't like a good fight, maybe they should reconsider!



**E**

Show TREMENDOUS MARKET POTENTIAL and need for financial products/services.



**F**

Show BIG PICTURE but focus in on HOW to get started and earn realistic EXTRA INCOME PART-TIME.



Share your local success and your upline's success stories, constantly reminding the guests that if you can do it, they can DO IT!

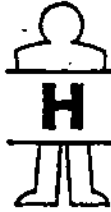

WRAP UP presentation by reviewing KEY POINTS.

To offer people a chance to "DO SOMETHING SPECIAL WITH THEIR LIVES".

To offer an alternative choice - "Buy Term and Invest the Difference."

Challenge the guests in this manner:

If they're interested in hearing more, they're asked to stay for brief orientation at conclusion.

If they're not interested, they may leave. Thank them for coming and encourage their doing business with you if they haven't already.

They'll never know for sure if they can do this unless they try.

The Challenge at the end of the meeting is very important. You want them to see that if they REALLY want to get ahead in life, they have to keep an OPEN MIND about opportunities. Study everything as if "this was the one." I tried many different career paths before I found the right one. If I hadn't kept my "trying machine" going, I wouldn't have made it. Stress to them that they ought to at least TRY.



After the Presentation

One of the most important parts of the whole evening will take place after your presentation. It's critical that you do not just let people slip away without trying to get their reaction or talking to them about the "next step."

Each "new person" should be linked back up to their ALW friend immediately at the end of the presentation and introduced to the person who is in charge of training. This is the beginning of the "follow up" system. Think positive! Always assume that a person will take the next step unless he or she shows something different by their hesitation or procrastination.

In my "Follow Up" system, I designate an office or room for the "meeting after the meeting" with new guests. Here I give them an appointment book, and "Decision Pak" materials to take home with them. This meeting should be brief, no more than 10-15 minutes. Everything should be over by 9:00 p.m. to allow guests to get home on time, to socialize with the most interested guests, to sign up the RED-HOT ones, or possibly because you need to rush off to a 9:15 p.m. home appointment! (Collapse Time Frames!)



## Monitor the Numbers

You **MUST** learn to monitor your pre-, your actual, and your post numbers at the Opportunity Meetings. I can't stress this enough. If you don't have a list of the names and addresses of the people who came to the meeting and who invited them, then you've missed a great opportunity to follow up later.

## The Humphrey Management Factory

The Management Factory is designed to help you solve one primary problem that tempts you as you build your super hierarchy: the human tendency to quit. I am talking about your tendency to quit building because you think you "have it made." For example, let's say I've hired Joe Stud. And I just know he's going to come to the Opportunity Meeting. I'm just certain that Joe is going to be a superstar. He's going to build a great organization.

So I quit talking to other people because I just know that Joe is going to come through. But Joe may not work out immediately. He may say he'll get back to me later. That's the killer. You can't stop building while waiting for a particular person to come through. You have to expect people to come in, but act as if none will.

## How the Factory Works

I spent more than 15 years of my life as a railroad conductor. Day after day, I was involved in the operation of the trains, whose primary purpose was to transport raw materials to manufacturing plants in various locations across south Georgia.

Years later, when I went into business for myself, I noticed a striking similarity between what I was doing and what I had been doing part of day after day on the railroad. I began to compare potential new people to "raw material," and my office to a manufacturing site. Here is how the analogy breaks down:

Plant	Management Factory
raw material	potential new hires
delivery/ transport system	new people and leaders selling the dream
processing site	opportunity meeting
screening/filter system	follow-up
finishing line	start up
volume production	the new people building more new people

# HUMPHREY MANAGEMENT FACTORY RECRUITING PLANT SYSTEM

BOATS



REPS

PLANES

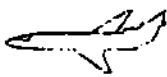

SALES LEADERS

TRUCKS



DIST. LEADERS

TRAINS

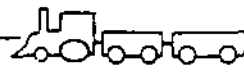

DVL/RVPS

## RAW MATERIAL - DELIVERY SYSTEM TRANSPORTATION

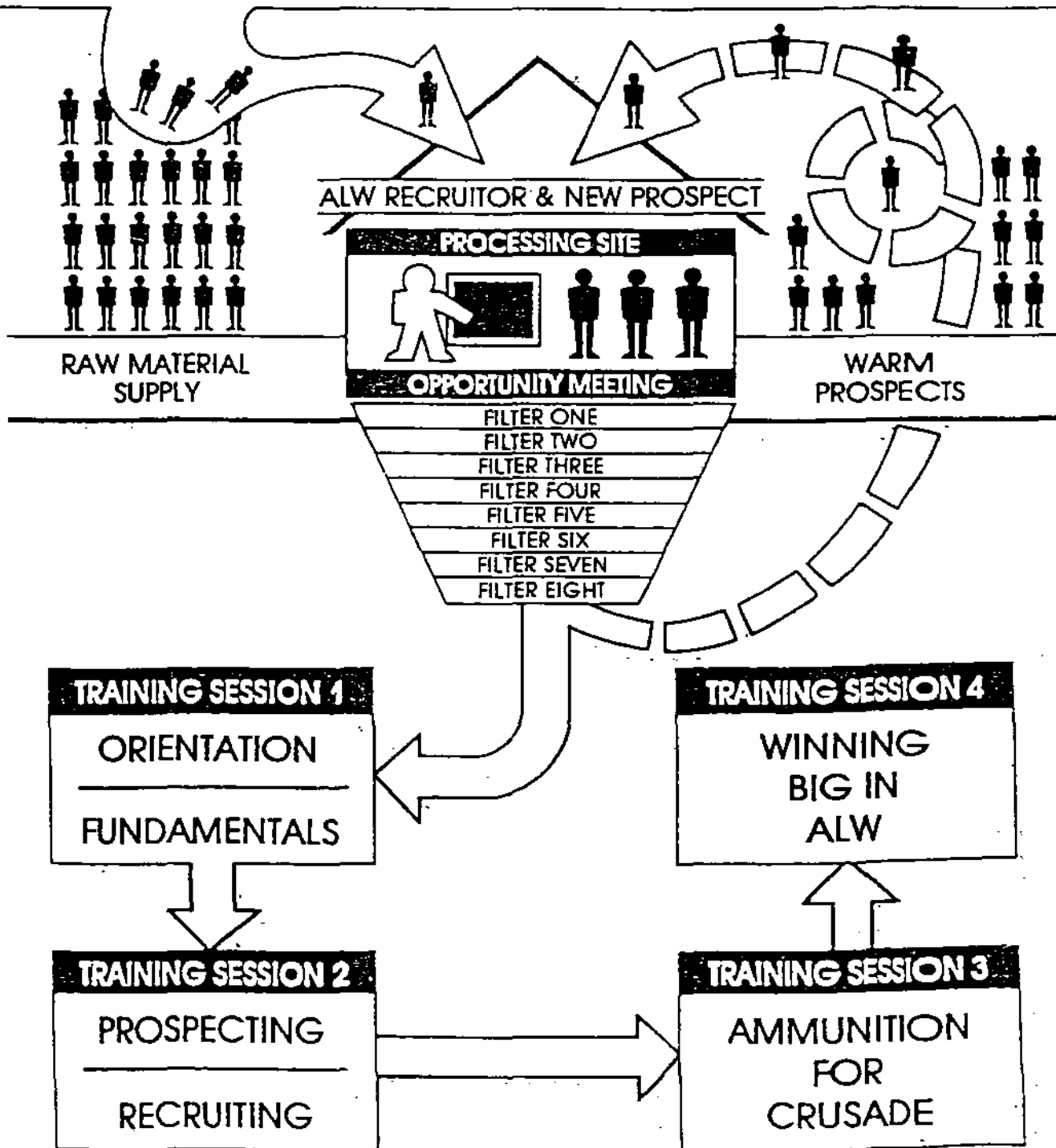

New people are the "raw material." The object is to get the raw material to the plant processing site or, in our case, the Opportunity Meeting. Each builder is designated as a "delivery vehicle." He or she is the transportation supplying the factory with raw material.

Look at the diagram on the previous page. The builder approaches the raw material supply, which are the prospects. He brings a prospect to the plant site (the Opportunity Meeting).

The "delivery vehicle" runs several times a week from the raw material supply to the plant processing site. This way, the "pipeline" stays filled with new potential people.

Once at the Opportunity Meeting, the new prospect moves farther into the factory system. He learns more about the company, what it does for the consumer and what it can do for him as a business opportunity. Meanwhile, the builder, after he has dropped off his "raw material" at the plant, goes to a "refueling station," or a training class.

After the Opportunity Meeting and the training classes are over, the builder joins up with his prospect. The builder then escorts the prospect to his manager, where he begins what I call the "8-Filter Follow-up." The follow-up is a series of steps that the new prospect takes to tell you just how committed he really is.

If he makes it through all eight "filters," then he becomes part of the Management Factory.

This pattern continues for at least four training classes. Meanwhile, the new

person studies state required education material and possibly, by the time he gets his license, he is ready to get started building his own business.

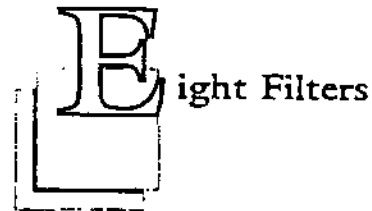

The follow-up system provides a means of testing the interest level of the new person. Each filter, or step, requires an additional commitment from the person. You should read his reactions carefully. They tell you how serious the person really is. Desire is the main ingredient to look for.

To start the follow-up, the builder must leave his training class in time to join up with the new person immediately following the Opportunity Meeting.

## **FILTER ONE**

### **Stay after the Meeting**

This step is simply a challenge to the prospects to remain afterward for a brief orientation. The keynote speaker ends his meeting by requesting that those who are interested should stay after the meeting. He also thanks those who are not interested and asks them to leave.

**FILTER TWO**

**Take Home Information**

Each new person should take home some type of information packet, something of value that will provide him with an increased knowledge and awareness of the opportunity you're offering.

The manager is expected to point out which materials will work best for that particular person. The idea here is that the prospect must take home something of value no matter what.

**FILTER THREE**

**Schedule Follow-up Interview**

If the prospect commits to a definite time within the next 24-48 hours to meet with the leader for a follow-up interview, then you know he (or she) is probably very interested. It's during this interview that he submits hiring papers. Set up this appointment the night of the Opportunity Meeting, and try to arrange to have it at the office.

I've seen too many people run all over the country trying to get hiring papers back and the person is conveniently not at home. There is no way of knowing whether the extra trouble that you go to for one person will be worth it.

Set up a daytime appointment, which will increase the prospect's level of commitment.

**FILTER FOUR**

**Prospects Submit Hiring Papers**

This is the ultimate indication of commitment. If the potential new person fills out the hiring papers, you can feel sure he or she has a serious interest.

**FILTER FIVE**

**Qualify Leads/Sign Letters**

If a prospect is truly interested, he will sit down with you and fully qualify his leads, signing referral letters (letters sent to prospects advising them of the opportunity). A really committed recruit will sign 20 letters of referral. When you are qualifying a person's leads, you should decide whether or not you need to:

- 1 go by
- 2 call the person by phone

Never treat him as if you're some greedy person trying to get names from him. Ultimately, the names will be helping to build his business. I talk to him about how great the possibilities are because of all the people he knows.

If you keep jogging someone's memory, he can come up with all kinds of names. Work toward getting as many as 100. Referrals from a new person are critical to his survival in the business. One of the biggest reasons for lack of activity in your office is that people are wasting too much valuable time on new people who have procrastinating tendencies.

The new person should personalize these letters with a handwritten "P.S." He could write something like, "I am going to try to drop by with my friend if at all possible. You'll really want to take a look at this."

These letters are mailed directly to new prospects. Even though the new person cannot participate in a sale until he gets his license, you should always try to take him with you to observe!

**FILTER SIX**

**Determine Immediate Goals**

You know a new person is committed when he tells you exactly what he wants to accomplish. You must find out why he is signing on, what he sees himself doing, and when he plans to attain his goals.

**FILTER SEVEN**

**Fast Start**

If a prospect will immediately go out with you to the homes of his three best prospects, you may have found a "super stud."

**FILTER EIGHT**

**Client**

Most new people who need our product and qualify for it, will buy it. This shows that they truly believe in the value of the product, and they are sincere in selling it.

**Review Your Results**

It makes sense to hold a weekly manager's meeting to review the past week's program and plan for upcoming weeks. Consider the following:

How many prospects came from each team?

How did the speakers at the Opportunity Meeting and the instructors in the training classes do?

Was the space adequate?

Did everyone go through a follow-up?

How many submitted hiring papers?

How many sets of policies/data were picked up?

How many referral letters were signed?

Which managers participated?

That's just to get you started. The important thing to remember is to always be trying to improve your system. Set a goal of developing a very mobile and building-oriented team of managers. This team should quickly build through their new reps. They hold the key to the team's success in this system by keeping a constant flow of prospects coming through.

The "plant superintendent" (the leader) should have a "building mentality" and the "vision of a master builder." He or she must constantly think and talk building and must be the top builder on the team each month.

When I built a base shop in Denver, we called it the Denver Plant of the Humphrey Management Factory. There was even a sign that said that. We had shifts, training shifts, to teach classes. The important thing was that everyone understood that the "raw material" was the people in the homes, and to get it to the plant site, we had to use "delivery vehicles."

The Management Factory produces successful leaders. It takes people, gets them excited, prepares them for their new career with thorough training, and sends them out as leaders who bring in even more prospects.

## Pushing Up People

There's only one way to go wrong with the Management Factory analogy and that's if you take it too far and don't treat people like people. You must take that pure business concept of getting raw material to the plant, and then understand that the raw material is a human being who must be treated with respect. If you can apply the principles of Pushing Up People you'll have it made.

## Cranking It Out

Just implementing the Management Factory for a few weeks or months is not enough to make you a success. Remember that one of the purposes of implementing a system is to keep you from the human tendency of quitting. The Management Factory will help you do that, but you must work at it, too.

It took me seven years to learn that no matter how good a guy is, you've got to keep on. You have to keep building. Expect people to come in, but act as if none will.

## The Buddy System

Part of an effective Management Factory is making sure that each of your new people receives proper training. Remember that **TRAINING IS CRITICAL** to your building program. You can't just hire masses of people and expect to build a Super Hierarchy. You must treat each new member to your team as if he or she were going to be a life-time leader, and that means **TRAINING** them.

I have set up a "Buddy System," that helps me handle the high numbers that come on board in a big office. All you do is select a designated trainer who can help you when you have a surge in new people.

Don't worry that your new people won't see you as their leader if you are not the one personally doing their training. You **HAVE** to have help, and in the end, it won't matter which leader trains them, they will still perceive you as the team leader.

I think of it like a woman having a baby at the hospital. She stays in there for a few days, and during that time, there are nurses who help her by changing the diapers and bring the baby up to the mother for feeding. But who does the baby remember when he grows up? Not the nurses who cared for him his first few days in this world, but the mother.

---

**BUILDING PRINCIPLE**

---

Work with those who deserve it, not just those who need it. Everyone needs your help, but you can't spend all your time working with people who will not meet you halfway by putting forth effort of their own. Every leader must make that distinction.

---

# Compress Activity/ Collapse Time Frames

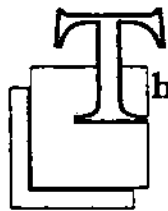

## The Big Success Secret

I have people ask me all the time, "Hubert, how in the world did you get such a big organization and make all kinds of money?" Certainly, some of my keys have been building and training large numbers, and duplicating myself as a leader. But another factor that has had a tremendous effect on my success has been my building "time frames."

Time management is one of the most important skills needed to build a Super Hierarchy. Since time is the major investment you'll make, you have to get the maximum return for your efforts. We all have 24 hours each day, but somehow, two people with the same apparent abilities and opportunities can get vastly different results! I'll bet there are some other people who have talked to as

many people or been exposed to as many prospects as I have, but who have never built a Super Hierarchy. Why? Because they hired and trained over a much longer time span. The results of your efforts are in direct relation to the time frames in which you work.

Think of it like cutting grass. If you spent 60 minutes cutting your grass, you would probably get a well-groomed lawn. But if the same 60 minutes were spread over 7 or 8 days in short increments, the desired result just wouldn't be there.

The same thing happens in building. If you bring one person on board per month for three months consecutively, you are diluting your efforts with too much time. By

the time person No. 3 is committed, No. 1 may have lost interest. It may not have looked to him as if you knew what you were talking about when you told him about the "big picture." What if you hired those same

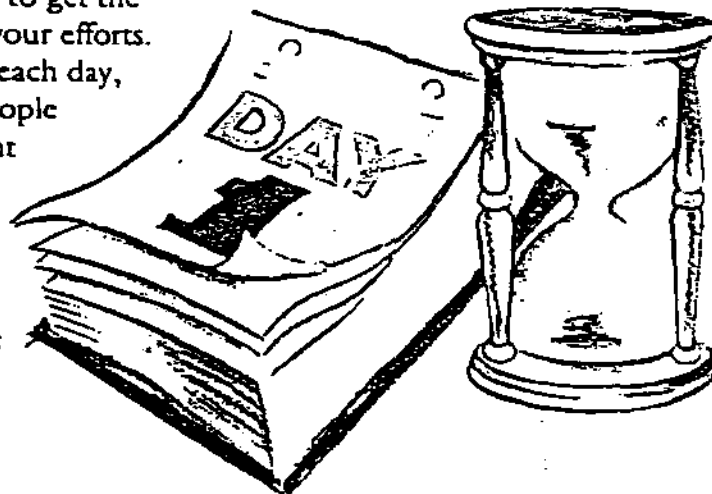



three people in one month? One week? One day? Or how about in one hour? These people see each other, they actually get to be in the room at the same time, and you have a team forming! They're sharing war stories and cheering each other on and keeping each other excited about the opportunity and the crusade. By compressing activity, you get different results.

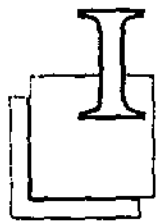

### Intensify Your Efforts

What happens when you compress gas? It explodes. How did I build such a huge hierarchy? I built and trained and built and trained until things exploded. By putting pressure on yourself and keeping up momentum all the time, you'll cause an

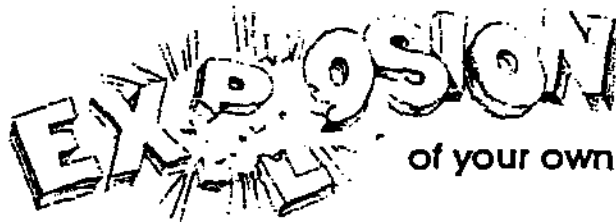

I remember one time very early in my career sitting down with one of my first new leaders. It was May 1, 1978, and we were trying to figure out a plan of attack for the next few months. He had all these prospects and I had all these prospects and we sifted through our list and determined the best ones. We were excited. We wanted to

make some progress. So we looked at our calendar and figured out who we could see from 8:00 to 12:00 and who we could see from 12:00 to 6:00 and who else we could see later that night.

Altogether, we wanted to make about 60 sales over the next 12 months. All the sudden, we said, "Why don't we do this stuff THIS month? All in this month?" We went out and did it. My leader's earnings were \$14,200 and mine were \$14,500. We didn't hit our goal of \$30,000, but we came close. More importantly, it changed me forever. It just blew my mind and made a different person out of both of us.

You must learn to concentrate, to FOCUS, to INTENSIFY your efforts. As you look at most successful people, you'll find that they probably compressed more activity into tighter time frames than others at the critical times in their growth.

There are plenty of smaller teams that worked just as hard, but the factor of "too much time" diluted their efforts. If the pilot of a large jet airliner doesn't "get after it" within the limits of the runway and get the speed up to 140 mph (the magical lift-off speed), he won't become airborne, no matter what else he does.

When I first started as a part-time sales representative, I always planned more appointments than I could keep. I would constantly call from one home to the next to reschedule my visit as I was having success. I never allowed myself to take the night off just because my one appointment either called to cancel out, wasn't at home, or wasn't interested. Too many of us rationalize valuable hours away by using the poor excuse that, "I tried."

Some important keys to remember are:

- 1 Develop a burning desire/a "Magnificent Obsession"
- 2 Crystalize your thinking/set a goal
- 3 Develop a game plan with clear steps and a deadline for attainment
- 4 Use a calendar and follow it daily.
- 5 Become a student of the business. Become an expert at what you do.
- 6 Don't let up for any reason. No slack.
- 7 Use the "ish" principle. Example: "I'll see you 7:00'ish"; this could mean up to 7:30 or 8:00 p.m.

Once you "lift-off," you must continue to climb until you reach the desired altitude and speed or you'll never reach your goal. Too many times you'll recruit a few people and ease off. You fall victim to the temptation of quitting. Imagine what would happen if the pilot of an airplane shut off the engines just after lift off!

Don't ever let up! Momentum is such a rare and valuable asset. Obtain it and don't ever lose it. When you find your next recruit, start that day to help him build his team.

## Maximize "Non-Productive Hours"

There is always going to be some time in the day when you physically can't recruit or build your team. When I'm in the car driving or flying somewhere or waiting on someone, I listen to success tapes in order to collapse time frames. I also use my car phone to call people in my hierarchy and give them good news or motivate them. Learn what the Law of Averages is in building and put the Law of High Numbers into effect.

But get after it right now, whether you're ready or not! If you hire and train 12 people personally in the next 30 days, you'll find that only about 3 or 4 winners will emerge and you'll have about 24-25 total new people in that period (12 by addition and 12-13 by multiplication). After you start to lay your foundation, group meetings, such as home or office opportunity meetings, allow you to maximize your time. By working in large groups, you are making many first presentations, visiting several homes, training many new recruits, all in the same hour.

Whatever you are planning to do in the next year, do it next month! Do next month's work next week. Let next week be completed tomorrow or in the next hour. I promise you the rewards will be worth it and your life will never be the same. You'll be propelled from mediocrity to excellence.

## Magic of the Blitz

I've found that short, 2-3 day blitzes work best when you are leading and motivating part-timers. It's very hard to keep a part-timer intense and excited about something over a long period of time. Their regular jobs and other factors get in the way.

I've had great success as have many of my leaders in having a Policy Pick Up (PPU) Blitz from Wednesday morning through Saturday night. I've also done recruiting blitzes, sales blitzes and "invitee" blitzes for Opportunity Meetings. Remember when you are blitzing that you don't do it for a long period of time, like 30, 60 or 90 days. A blitz is a surge within this period of time. Blitzes are all-out, intensive attacks on mediocrity. They may START momentum. If you wanted to start building your Super Hierarchy today, you might plan a blitz to get things going. When all else fails, the blitz gets you to CHARGE. Just always remember: the first person you have to get moving is YOU. Don't just try to get your "team" moving. The ONLY way to have a successful blitz is for you to lead the pack!

## Stretch for Success

One of the most successful tools I have used to produce new levels of activity has been my Stretch for Success method. It is based on what I call the "Volcanic Eruption Principle." After a volcano erupts, what

happens? The lava flows down the side of the mountain. When it hardens, you have a new, and bigger mountain. Then, the next time it erupts, what happens? You know you're going to get an even BIGGER mountain because of the layers underneath.

It's amazing how you can produce the same effect with activity in your office. If you work toward a big "eruption" in your growth, then you will find that your new production "low," from that point on, is higher than your old production "high."



The way to create an "eruption" is to challenge your people with some very simple performance incentives. Run this contest for one-month's time and call it a "Super Month." I like to give my months catchy names like: "Nuclear November" and "Gigantic July." This helps form a MENTAL PICTURE in the team's mind. Cap off the end of the contest with a big event such as an Awards Banquet and give LOTS OF RECOGNITION! You'll find that your future "low" production months will always be higher than your old "high" production months!

## The Magic of 90-day Madman Cycles

You can do ANYTHING for 90 days. All you have to do is set goals, develop a game plan, put your head down and go for it.

I have developed a "90-Day Madman Cycle" that can produce incredible results during a year's time. Looking at the chart, you see that I have established four 90-day cycles. They are concurrent, meaning that they overlap with no gap in between.

You don't work like mad for 90 days and then take a break. There's no slack. If you finish your goals for the first 90 days early, then you start immediately on the goals for the second 90.

Now look at the first cycle. Beginning in this one and each one thereafter, you go out and get 6-12 personal recruits. The actual goal will depend on your individual market and your personal recruiting capabilities. You spend 90 days recruiting and training these people. During that time, you will be able to identify and develop one to three Fireball leaders.

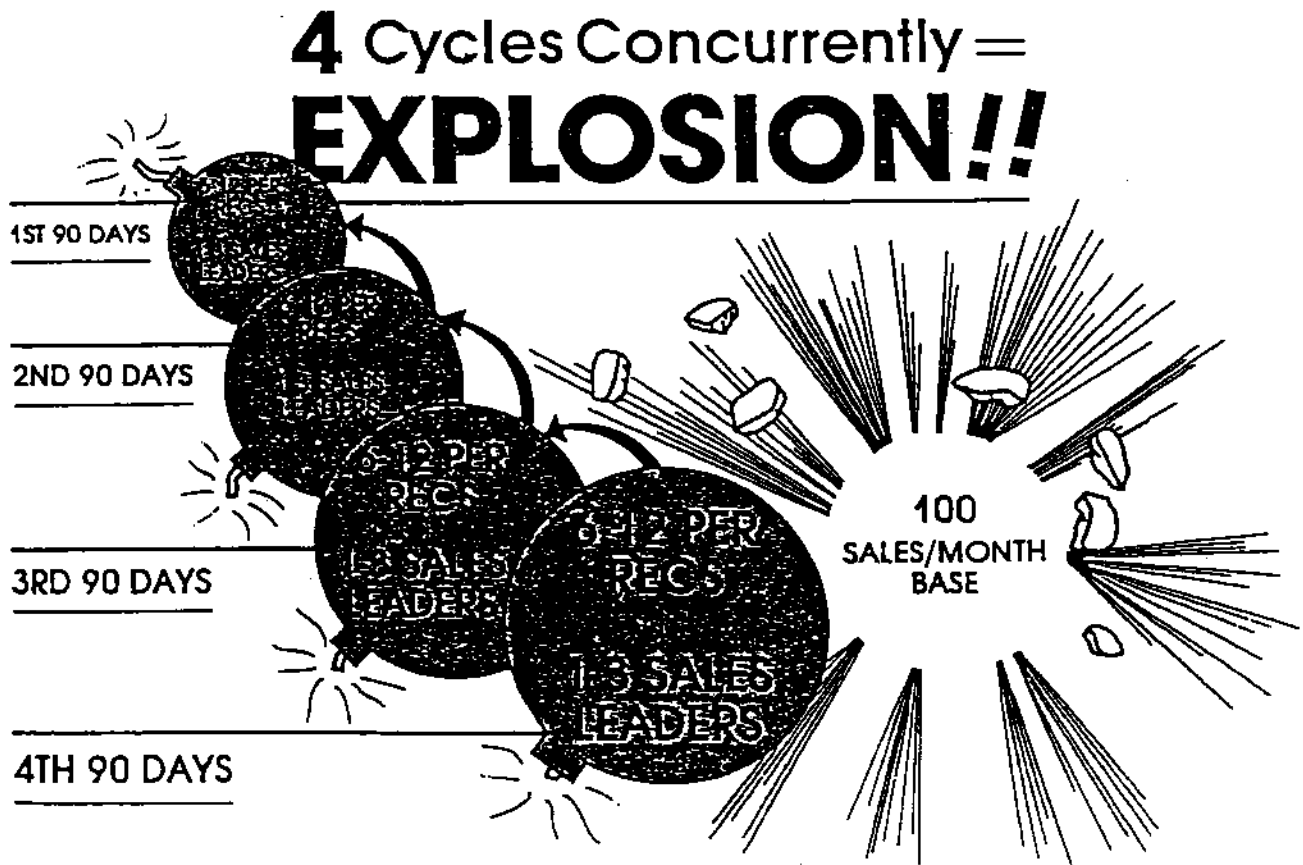

In the second 90 days, you start another expansion. You work to find and train another 6-12 people and develop one to three new leaders. IN ADDITION, you've got to go back and continue to make sure the momentum you started in Cycle One is still going. To do that, you go back and work with people from Cycle One. Don't just plunge ahead into Cycle Two expecting what you did in Cycle One to perpetuate itself. Even though you have tried to develop new leaders to help with training and motivation, YOU are still ultimately responsible. You must be there to help those who want and deserve your assistance. Remember our Chinaman with the spinning plates? Every time he got a new plate spinning, he had to go back to his very first ones and give them another turn to keep them going.

The rest of the chart is somewhat self-explanatory. You move into your third and fourth 90 days with the same goal as the first two cycles. By the time you reach Cycle Four, you should have 20 - 50 new people and somewhere between 5-15 strong leaders. Your office will be running at a high quality level, producing about 100 sales a month and \$50,000 in premium.

During your Madman Cycles, you should try not to get "too high" or "too low." And you should not stop for any reason.

All I did when I moved to Denver was to put together eight consecutive 90-Day Madman Cycles. In the two years I was there, this effort laid the foundation for the giant explosion of my Super Hierarchy. When I

moved back to Georgia, I just continued with eight more cycles. And when I restarted my base here almost two years ago, I did eight more cycles in two years. This positioned me for another major explosion.

The whole story of Hubert Humphrey's success has been just a linking together continuously of 90-Day Madman Cycles. In the process, I have been able to duplicate this downline and produce leaders who do their own Madman Cycles.

Review the results of your efforts ONLY after 90 days. As you make your assessment, "recommit" for another 90 days for new and greater goals or consider "getting out" of this business! Don't be discouraged if your first 90 days didn't turn out exactly according to plans. If you were just a "salesman," you probably would have been able to see immediate results from the beginning of your first 90 days. But you are in management, and you are building for the future.

## **E**xplode to Excellence

Your goal in collapsing time frames and compressing activity is to begin a tradition of excellence in your Super Hierarchy. If you get to the speed I just mentioned and maintain your base at 100 sales a month, you'll probably be promoting people every couple of months. Remember that you must continually cultivate new leaders.

If you maintain a thriving, producing base, you'll set a strong example for your newly promoted leaders. They'll have "greatness in their genes," and they will naturally want to follow the example set by their leader. I have found that when my base shop is the biggest, the RVPs I produce are motivated to produce more. They haven't just been promoted out of my office, they've **EXPLODED OUT**, like energy from a "Super Nova." They aren't comfortable with a little bitty base shop for themselves. They come out with their **VISION** stretched and they are on fire!

The chart on the following pages depicts this concept. It shows how after three RVPs have exploded out, you become an SVP with a strong base shop. After four more RVPs, you become a National Sales Director.

Building a Super Hierarchy basically comes down to two options: 1) the long, grind out way, or 2) the explosive, Super Nova way that perpetuates a tradition of excellence. Which do YOU choose?

---

### BUILDING PRINCIPLE

---

The speed of the leader determines the speed of the team. Do it first.  
Lead by example.  
People won't follow you just because you talk a good game. Do it first.

Sales is a business of momentum. When you've got momentum, you must get all you can get. Develop a sense of urgency, and never let up, whether conditions are good or bad.

---

# SUPER NO

## EXPLODE TO

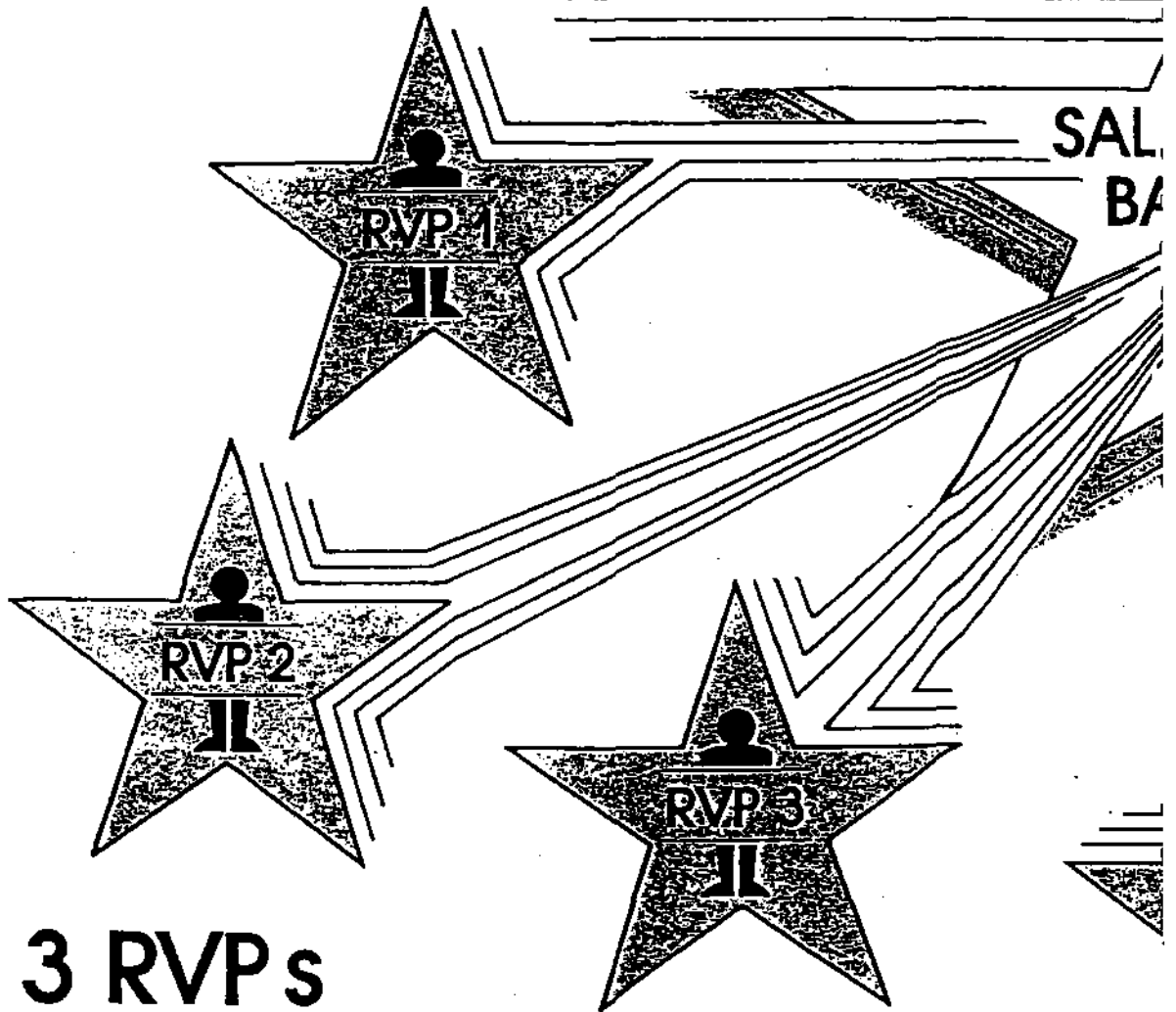

**3 RVP s  
EQUAL  
SVP**

## TWO WAY

THE LONG "GRIND IT OUT" WAY

# A CONCEPT

---

---

## EXCELLENCE

---

---

3  
MONTH  
SHOP

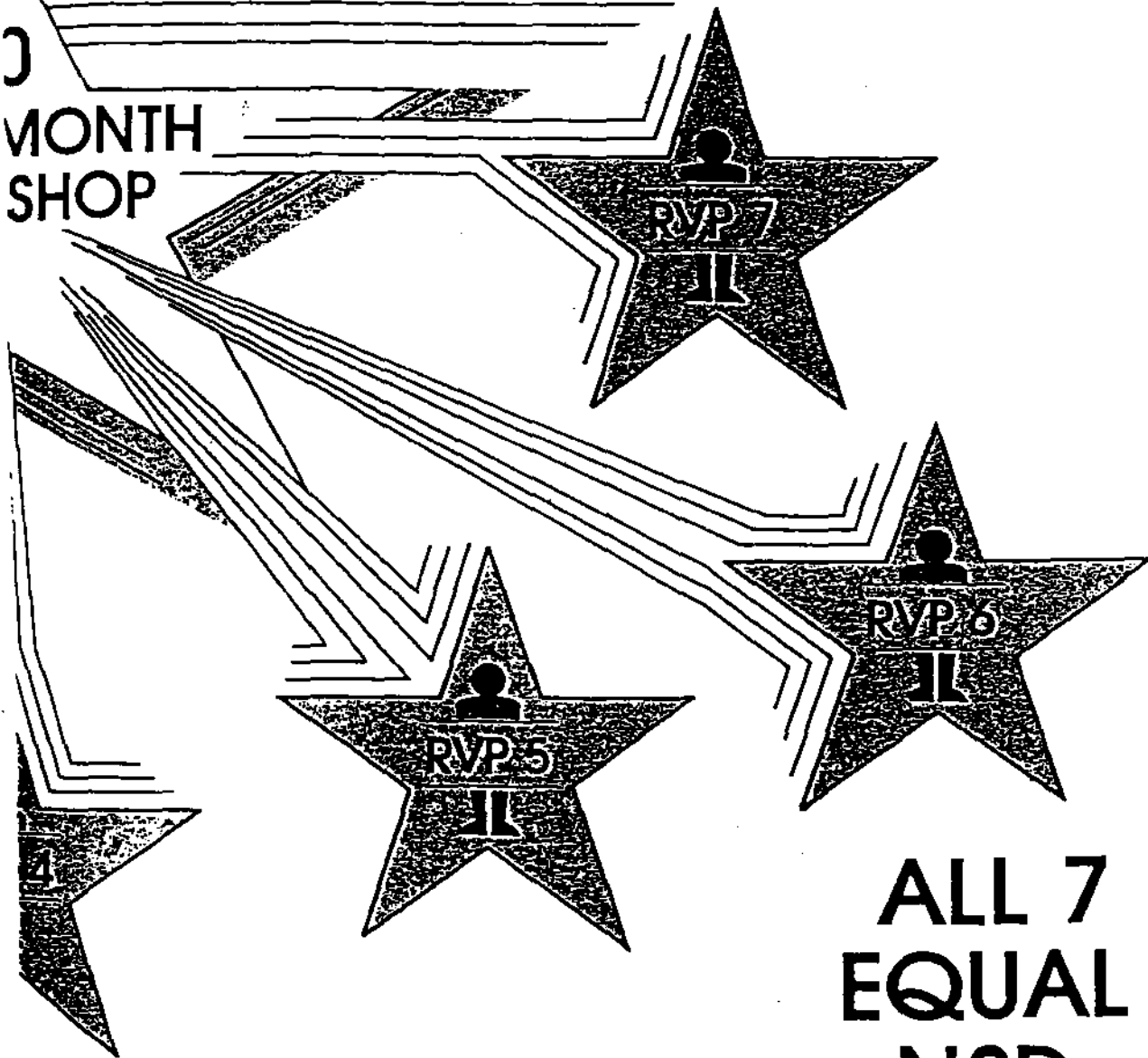

ALL 7  
EQUAL  
NSD

---

## TO GET BIG

---

THE EXPLOSIVE "SUPER NOVA WAY"

---

---



# Profile Of The Great ALW Super Hierarchies (THE GREAT APES)

## North American Sightings

The Great Apes are among the most intriguing animals on earth. They're a rare species that exists only in a secluded rain forest area of Africa. A.L. Williams started with a group of Great Apes, but several years ago they were in danger of becoming extinct. Recently, there have been some sightings in scattered parts of North America that prove that the Great Apes in A.L. Williams are still alive. There's been a sighting in southern California, one or two in Georgia, several in Texas...

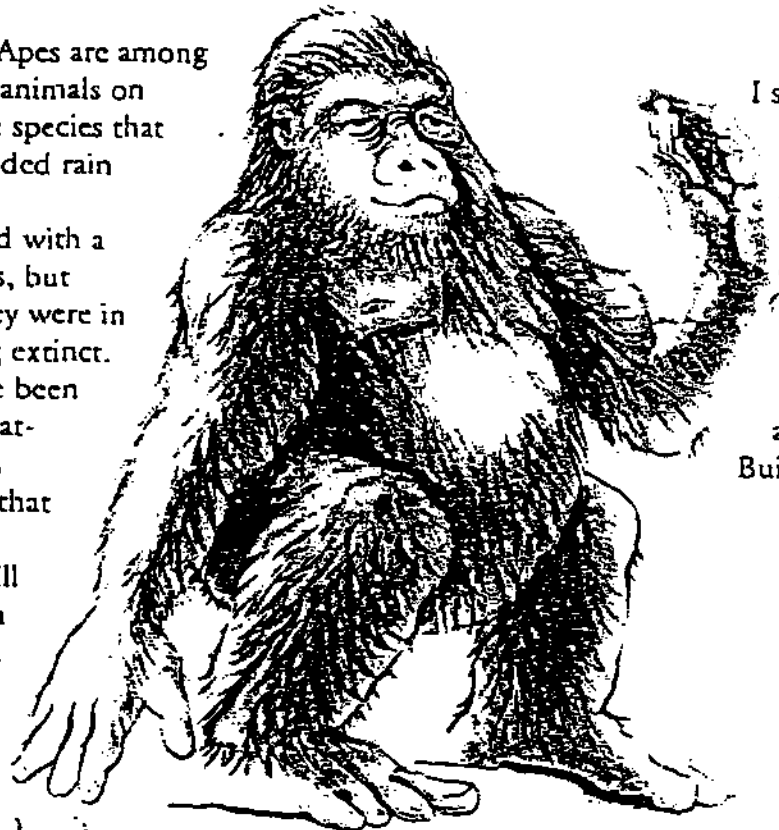

I suspect you understand my point. These Great Apes are the A.L. Williams Super Builders who have built the Super Hierarchies. The next pages are a result of a study of the Super Builders.



## They Built Great Base Shops

All of the Super Builders in A.L. Williams did more than recruit and train a few people and work downline. They all built Wide, and maintained big base shops, producing \$100,000 - \$200,000 in premium a month. They all ran big Opportunity Meetings systems, and were successful in recruiting and training 100 or more people a month in their base for several years. They built strong personal relationships with all of their key people.

## They Built Strong First Generation RVPs

Each Great Ape has produced 20-75 first generation RVPs, and most have produced more than 25. These RVPs EXPLODED out in a rapid stream. Out of that group, the RVPs were able to develop 10-25 tremendously strong first generation RVPs (NSD-type people) downline from them (second generation to the Great Apes). All the while, the Great Apes continued to run a giant base that set the big, stretching example for each wave of new RVPs. As a result, some of the RVPs developed a burning desire to establish their own giant base. For those Great Apes who didn't continue to run a big base, some of the magic left for their first generation.

Another characteristic of RVPs of the Great Apes is that these first generation people were "independent" versus "dependent." In other words, they didn't just get

that person to RVP by the guidelines, they developed the RVP according to a standard of excellence that enabled the newly-promoted person to lead a team by himself. The following are 10 points to develop in an independent RVP leader:

- 1 Attitude - Totally positive, loyal to the spirit of the business
- 2 Income - Cash flow of \$6,000 - \$9,000 per month
- 3 Business Sense - A student of the business manages activity and focuses on results; makes money/saves money
- 4 Quality Business - Strong field underwriting; strong mutual fund/strong total concept
- 5 Strong Builder - Replaces himself with a team capable of 20-30 sales a month; team leader should have a recruiter/builder mentality
- 6 Office - Moves out of upline's base shop complex to begin on his or her own; has upline NSD approval
- 7 Secretary - Hires a sharp administrative person
- 8 Savings - Sets aside \$10,000 in cash to assure at least one year's rent
- 9 Strong After Replacement
- 10 Motivation/Communication - Is a good leader, good at motivating and communicating downline

## **T**hey Produced Giant NSD/SNSD-Type Teams

The first generation RVPs of the Great Apes maintained big base shops for 4-5 years solid. These bases produced 15-30 RVPs front line to them (Seconds of the Great Apes) and out of that 15-30, came 7-10 tremendously strong NSD-type leaders under them. The process was duplicated through at least six generations. All the while, the original "Great Apes" continued to lead by example with a giant base shop as did others throughout the hierarchy. (My recommendation is that you make a commitment TODAY to run a big base shop for 10 years or more. Make that kind of commitment and everything you want will come from it).

## **T**hey Became Master Motivators

The Great Apes mastered the art of motivation to large groups of people at all levels. They worked with every RVP as if they were first generation to them. They held big events to give major recognition; they mastered the art of personal letters, newsletters, monthly leaders bulletins and conference calls. They made the commitment to go and visit people locally.

## **C**onstant Personal Motivation

The Great Apes communicated almost daily with their key people for two years. In my hierarchy, I spoke with my key people every day, whether we were a thousand miles apart or in the same city. There are four types of communication to have with your leaders.

- 1 Motivation - praise when someone does well
- 2 Encouragement - the most important if your RVP is "down"
- 3 Good News - everyone loves it
- 4 Know-how - new ideas, new systems, new techniques



## High Octane Motivation

The Great Apes all discovered that communication is the key to maintaining a big base. In my Super Hierarchy, I have worked to build a giant "irrigation" system using conference calls and letters. It reminds me of General Patton's tank army. It was much more powerful than the traditional foot soldier army, but it presented a whole new set of challenges. The tradition foot soldier could get by on C rations and bandages. But the tanks needed fuel and lots of it. They thrived on "high octane." It was never easy managing the constant delivery of fuel to a moving army, but in the end, it was worth it. The tank army was so powerful it could devastate the enemy.

When you are building a Super Hierarchy, remember that you need to use High Octane Motivation to keep it going. A tremendous effort toward communication, training and motivation is key.

## They Couldn't Live with Being Average and Ordinary

All of the Great Apes have the heart of a champion. They were born with an extraordinary amount of desire. The reason they built it big was because they just "had to." They couldn't live with themselves if they weren't the "BEST."

## The Magic of Expansion

All of the Great Apes were expansion-oriented and built multiple base shops. They weren't content with an isolationist mentality. They ventured out and pioneered other areas.

There are three correct methods of expansion.



**1**

**Leader transplants himself to new area.**



This is the purest and best way to expand. It's the way I expanded into Denver. I could have sent someone that I groomed, but I promise that if I had, I wouldn't have been writing this book today. Moving to Denver not only had a major influence on me, it stretched me beyond belief. I came from the poor side of a small Southern town, but I moved my family to Denver and duplicated the base shop building effort that I had first accomplished in Macon.



**2**

**Raise leaders in your base shop and satellite them out.**



The second best way to expand is to raise a strong leader in your base and then send him or her out to an area of their choosing. One of my first generation RVPs was raised as a leader in Denver and then he went back to southern California, where he was from. I raised another person as a leader

in Denver and he returned to his home town of Austin, Texas. When you expand this way, you ensure that you have an experienced person with vivid impressions of what he must do.



**Find a strong leader-type person in a certain area and build through him or her.**

This is the least preferred of the three correct methods of expansion. It takes longer and it takes more financial commitment, but it will still work. Every one of the people that expanded from me in this method found me **FIRST**. I didn't go looking for them. They were a referral or they heard about A.L. Williams and contacted me. In short, I came to meet them in a natural, unforced fashion. They were all good with people. They were honest with good reputations. They had sound financial situations (very important).

Below are the two criteria for this expansion method:

- 1 You must be a strong leader who can afford to travel to them.
- 2 They must be strong enough for you to build on.

You must be able to afford to visit them, but you must **NEVER** start out that way. They should visit you a minimum of two to three times before you visit their local territory. For example, one of my RVPs was the first A.L. Williams person in

Missouri. He came to Denver twice before I ever set foot in Springfield. Another of my RVPs came to visit me from Wichita. And still another came to Atlanta twice before I ever went to Milwaukee with him.

Your final consideration in this expansion method is **MONEY**. I was at a point in my career that I could handle the demands. I was making over \$200,000 a year. I had a base that was running over \$100,000 in premium each month. I was at least 50 wide in my base and had 10-15 strong leaders. When I left to visit the expansion office, these leaders were capable of running the Opportunity Meetings and the training on their own. I could afford to travel and subsidize them and help them with monthly support money. There is always a sound business basis upon which successful expansion occurs.

What is unsuccessful expansion? Typically, I see people get a name in a far away place that they're all excited about. They use last month's rent on an airline ticket they can't afford to go rushing up there and work with this person. They're jumping on quick sand. Then there's the "sling it against the wall" expansion mentality, the "send them a kit through the mail" mentality and others. In all of these cases, the RVP is just hoping against hope they've found a good person. Usually, futile hope. **THINK** and **PLAN** before you **EXPAND**.

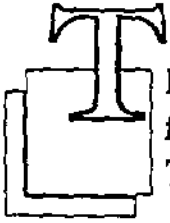

They all Set Goals  
for Themselves and  
Their People

Each of the Great Apes recognized the importance of setting goals, both short-term and long range. They also saw the value of setting goals for members of their team. I see a lot of people capable of setting goals for themselves, but they miss out on a whole other dimension of management by failing to set goals for their people.

In my hierarchy, I send out "Possibility Projections." These are projections of how many recruits or sales or how much production each person in my base will do in one month's time. It helps **STRETCH** the vision of your team. I get people coming into my office all the time, saying, "Hubert, how am I supposed to make this projection?" Then, I sit down with them and go over a step-by-step plan that will produce the projected amount.

A similar method of goal setting is Promotion Time Tables. These are printed projections of the month that a person in your downline hierarchy will achieve a certain promotion. For example, I have a posted list of a "Promotion to Senior NSD Time Table" that includes everyone of my NSDs. I have a "Promotion to NSD Time Table" that includes all my RVPs. Even if the person doesn't make it, it gives them something specific to shoot for. They have a **MENTAL PICTURE** of themselves becoming that new person.

They may have used different names, but each of the Great Apes had some type of Standard of Excellence that produced above-average leaders.



Art Williams On Building

I'd like to leave you in this Chapter with a final thought that has always been true of the Great Apes.

**"Leaders that build a big base shop and keep producing first generation RVPs...then to those leaders go the greatest honors and greatest rewards."**

Art Williams, 1986

# C H A P T E R T W E L V E

---

## BUILDING PRINCIPLE

---

Before you can become a great leader, you have to become a great person. People don't accept your leadership just because of your position. Regardless of how good you are, your people see you FIRST as a person.

---

# My Story

**R**emember that your personal story is always the best way to express the hope and opportunity that A.L. Williams offers.

Always have a personal story. Tell events of your life that have a moral or a point to them and always make it easy for someone to identify with your feelings. Always remember what it was like for YOU.

A lot of people don't believe me, but I started working the year I was born. I paid for the whole first year of my life. My mother and father didn't have a lot of money by any means. In fact, they fell immediately into debt the night of their honeymoon. My Dad had borrowed my uncle's car, and they were driving along the road on the way to Florida, and the car swerved off the road and into a pasture where it hit and killed a cow. Not only was my uncle's car all banged up, but the cow happened to be the prize winning animal of the farm. Between trying to pay for this mess and the hospital bills, my parents needed all the extra money they could get. So when I was born, my mother put me to work right away. She entered me in a Carnation Baby Contest in Macon,

Georgia. They were giving away some savings bonds and a year's worth of diapers and Carnation Milk. I ended up winning. I didn't cost my parents hardly anything for about a year.

I can't say for sure, but this turn of events must have had something to do with an early predisposition I had to be an entrepreneur. I had my first paying job at age 12 as a stock boy in a grocery store. When the older and regular delivery boy quit, I quickly grabbed the chance to become the local delivery boy using a bicycle. My short legs could hardly touch the pedals. From the time that I was a small boy until after I started college, I had many jobs. I was a soda jerk, I worked at a bakery, I did construction work, I was a plumbers assistant. I worked at a heating and air company, two service stations and managed a shoe store and a vending company.

I attended Georgia Tech for two years before realizing that I didn't want to be an engineer for some big corporation. I may be one of the few people to make the Dean's List at Georgia Tech for every quarter I was there — then drop out in two years. During



this time I married Norma, the perfect wife and partner for a dreamer like me.

Just by chance, during the summer of 1962 while home from college, I took what I thought was a part-time summer job with the railroad. It turned into a 17-year J-O-B. For the first four or five years, the idea of working on the railroad seemed intriguing to me. Gradually, the romantic idea of being a "railroad man," wore off. I hated being away for days at a time and working all night or getting up at 5 o'clock in the morning to go to work. Sometimes, I felt like an indentured servant. I was just a number. In fact, I still remember my number. I was 42818. That was me. Today, people ask me, "Hubert, do you ever dream of working on the railroad?" and I say, "Yes, when I have nightmares, I do."

During that time I learned a lot about myself. I learned what it was like to want to "be somebody," but to be trapped in a job working for someone else. As each year wore on, I became more and more frustrated. I didn't want to work for a company that paid jobs I wanted to work for a company that paid people. But I couldn't just walk away. My family was growing, and I had heavy responsibilities.

What was even worse, as I looked around, it seemed that things had changed for me. Life didn't look so full of potential anymore. It seemed that the business avenues that had been opened to me after high school were all closed now. Everything I thought about doing either required a lot of money or a lot of experience, or it required quitting my secure job. It was a little scary to see "no way out."

At first I was discouraged. Then determination set in. I began reading motivational and self-help books. I committed myself to growing, and eventually, I came to a fantastic realization. I came to the realization that I didn't have to be a "railroad man." When I was born and that doctor held me up by my feet and spanked my rear end, he didn't stamp "Railroad Man" on my behind. I could be ANYTHING I wanted to be.

From the time that I "woke up," I spent the next 12 years trying to get out of my rut. I wanted freedom more than anything else. I really wasn't motivated by dreams of becoming wealthy or making a tremendous amount of money. I couldn't comprehend that sort of thing. Norma and I had three children and one on the way. All I asked was an opportunity to keep my same standard of living, yet be my own boss.

My peers just laughed when I told them about dreams of being able to go into business for myself. But I did one smart thing. I kept an open mind. I was always looking and searching. In the late 60s, many different so-called "opportunities" came our way. They were ventures with different marketing companies. I won't go into great detail, except to say I stuck it out with one of the ventures for seven years, thinking this would be my great escape from the railroad. Even Norma believed, just like I did, that this time, it would work for us.

I sacrificed more than half of my railroad working time, only to find myself under tremendous financial pressure. But for seven years I hung on. And every time I would get up out of that ditch and put my

fingers right over the edge, somebody would step on them and I would fall back down. I was becoming more and more frustrated. I wasn't a quitter, but I was considering it. I had my hands half raised in surrender.

About that time, along came a part-time ALW rep who had only just started.

I remember exactly the way he recruited me. He had sold me \$200,000 of coverage for less money than I was paying for \$62,000. I was a satisfied client. Not more than a month later, he brought my policy back to me, and I could tell he was excited about something. I said, "What are you so excited about?" And he said, "I just quit my job!" (He sold pianos and organs in Macon.) Then he told me that the week he had come to see me, he had made \$3,000. I said, "What? \$3,000?" He said, "And since that time, I've made \$2,000. So in a month and a half, I've made \$5,000."

Envy started to set in. I had spent 12 years trying to get away from that prison in the railroad and here was a guy selling pianos at the mall telling me he just made \$5,000. He tried to explain his override system and I could tell that he barely knew beans about the marketing potential of his new job. But I knew. I could see right away that this sounded better than any venture I had seen while working on the railroad. It hit me like a ton of bricks. All those years of trying this, and trying that, and keeping an open mind paid off. I knew then and there this was IT for me. This was my chance for FREEDOM.

The first thing I wanted to do was to go tell other people about it. I wanted to start right away. I came on board and my first goal was to beat that piano salesman. He

made \$5,000 in a month and a half, so I made \$6,000 the first 30 days after getting licensed. I made over \$70,000 my first 7 months and over \$100,000 my first full 12 months with ALW.

In late July of 1979, 18 months after starting, I moved my family to Denver, Colorado to build "my company within a company." Now the magic of compound dreaming could really take off. I couldn't believe that this was really happening for me. I was both excited and scared. I remember when I first joined the railroad. They promised me I was really going places. I did: Albany, Atlanta, Columbus, places I didn't really want to go. Also, I remember when I left the railroad, I had mixed emotions: joy and happiness. Now here I was in Denver with the freedom and responsibility to make my own future. I was in business for myself, but not by myself. I had learned a lot about the fundamentals of the ALW crusade and the ALW way of doing business.

But the real key to my success was that I had learned how to have a builder's mindset. I practiced this philosophy: knowledge doesn't produce activity, but activity does produce knowledge. I went to Denver with one mission: to build a network of outlets.

In my first month in Denver, I had 12 personal recruits. Many of our original RVPs came from this group. After two months in Denver, Norma and I were promoted to RVP (October 1979). We had the greatest business opportunity in the world. After 90 days, we had 350 people recruited. At the end of 6 months, we had over 1125 people and had produced our first RVP.

It was during this time that the "Humphrey Management Factory" concept was born. We set up a system whereby building would never stop. We learned the power of the words "hold a meeting." We introduced Opportunity Meetings to ALW, and through our hard work, and the tremendous efforts of many wonderful people who came our way, the Humphrey World Wide Network was born and was destined to become ALW's team of the first decade, 1977-1987

Today, Norma and I have built one of the largest hierarchies in A.L. Williams. In doing so, we have built an estate that will provide financial security for our children and our children's children and perhaps beyond. We have been able to help our parents and family members when they needed financial support. We have been able to travel and provide the best for our family.

But you know, when I leave this earth, and if I've made millions of dollars and own anything I want, it will all be minor compared to one thing: the fact that, at age 36, I escaped from the railroad, and I don't have to go to work for someone else ever again. The funny thing is, I wouldn't take anything for those years I worked on the railroad. Do you know why? Because they made me appreciate the freedom that I now have.

One of the first steps to greatness requires a lot of courage. You must first see

yourself achieving the dreams you once had. The next step is to TRY. Try to make your dreams come true. Never give up. Keep an open mind. Always be searching for YOUR personal opportunity, whatever it is. And remember one thing: it CAN be done. I know, because it happened to me.